

## Electrical linear actuator with safety function MC100FSR/230

### Application

Linear actuator with automatic coupling and safety function for fine stroke adjustment of two-way and three-way valves.

The linear actuator is controlled with a 3-point signal (open/stop/closed).

The linear actuator includes a safety function, which uses spring force to open or close valves (depending on the type of valve used) when the power supply is interrupted.

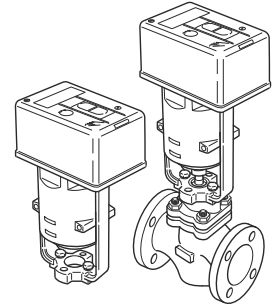

Content	Page
Important Information on Product Safety .....	2
Electrical linear actuator with safety function MC100FSR/230 .....	3
Technical Data .....	3
Dimensions .....	4
Connection .....	4
Linear actuator functions .....	5
Installation .....	6
Valve Installation .....	8
Mounting .....	9
Removal .....	11
Commissioning .....	13
General Information .....	13
Commissioning Steps .....	14

## Important Information on Product Safety

### Safety instructions

This document contains information on installing and commissioning the product "MC100FSR/230". Each person who carries out work on this product must have read and understood this document. If you have any questions that are not resolved by this document, you can obtain further information from the supplier or manufacturer.

If the product is not used in accordance with this document, the protection provided could be impaired.

The applicable regulations must be observed when installing and using the devices. Within the EU, these include regulations regarding occupational safety and accident prevention as well as those from the VDE (German Association for Electrical, Electronic & Information Technologies). If the device is used outside of the EU, it is the responsibility of the plant engineer or operator to comply with local regulations.

Mounting, installation and commissioning work on the devices may only be carried out by qualified technicians. Qualified technicians are persons who are familiar with the described product and who can assess given tasks and recognize possible dangers based on their technical training, knowledge and experience, as well as their knowledge of the applicable regulations.

### Symbol meanings



#### WARNING

Indicates a hazard of medium risk which can result in death or serious bodily injury if not avoided.



#### CAUTION

Indicates a hazard of low risk which can result in minor or medium bodily injury if not avoided.



#### CAUTION

Indicates a hazard which can result in material damage or malfunctions if not avoided.



#### NOTE

Indicates additional information that can simplify working with the product.

### Notes on disposal

In accordance with the applicable laws and directives of the European Union countries, the product should not be disposed of with household waste. This ensures environmental protection and sustainable recycling or raw materials.

Commercial users should contact their supplier and observe the conditions of the purchase agreement. This device may not be disposed of together with other commercial waste.

The local and currently applicable laws must be observed.

**Electrical linear actuator with safety function MC100FSR/230**

MC100FSR/230 AC 230 V linear actuator with 3-point control  
 Safety function: **Linear actuator retracts without power**

**Technical Data**

Nominal voltage	AC 230 V $\pm$ 15%, 50/60 Hz, 30 VA
Control	3-point signal (open/stop/closed), optionally via - 230 V energized control or - contact inputs
Drive	Brushless DC motor
Priority switching	Direct control via voltage-free contact inputs "Z2"/"Z3" as - 3-point control (open/stop/closed) or - 2-point control (open/closed), e.g. frost protection, limitation (Connection parallel to energized control from the loop controller)
Actuating stroke	Max. 20 mm, automatic stroke adjustment through initialization
Positioning time	9 s/mm actuating stroke
Emergency positioning time	Approx. 1.0 s/mm
Thrust	1000 N
Position indication	Stroke range scale
Position feedback	DC 0–10 V, 5 mA for 0–100% actuating stroke
Valve monitoring	Automatic valve block control with error message greater than approx. 12.5 V
Valve block protection	Optionally adjustable
Manual adjustment	Socket for hexagon socket key beneath the drive cover, key socket 4 mm, locking using knob
Ambient temp.	0–50 °C
Degree of protection	IP54
Protection class	I in acc. with EN 60730
Installation position	Anywhere from vertical above the valve to a horizontal position
Maintenance	Maintenance-free
Weight	2.80 kg

**NOTE**

For a positioning time over the entire valve stroke of 108 s, 126 s, 180 s or 135 s, the positioning movement is performed step-by-step with periods of inactivity of approx. 5 s. This operating characteristic corresponds to normal state.

Dimensions

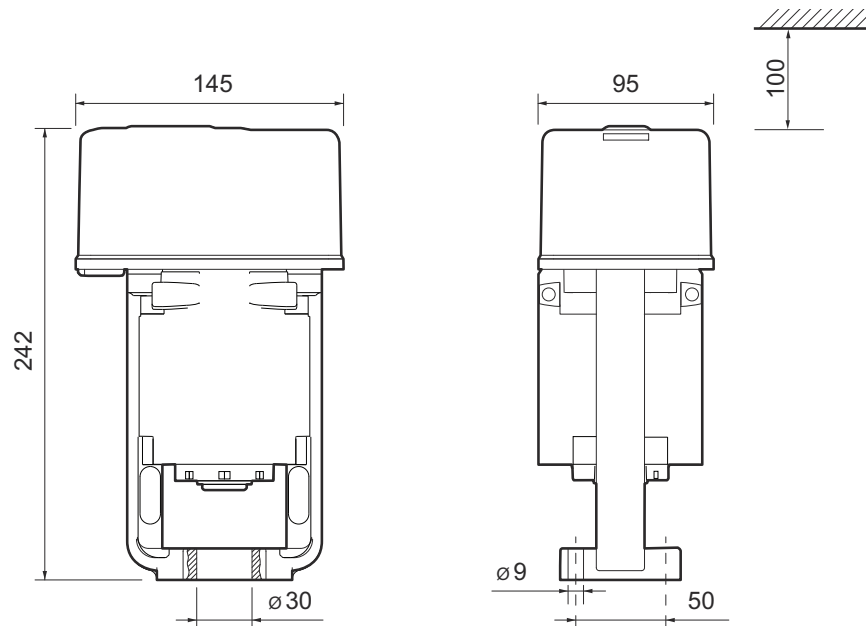

Connection

3-point control AC 230 V energized

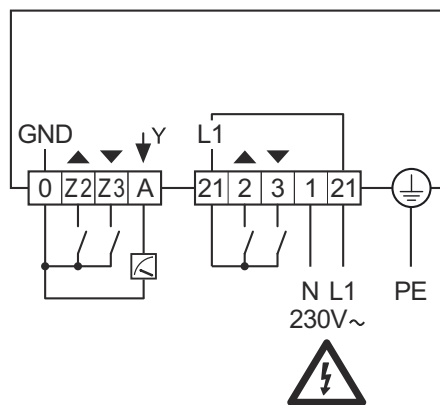

## Linear actuator functions

### Automatic mode / Testing the safety function



(1) Switch  
(2) Indicator slide

Automatic mode or testing the safety function can be selected directly on the linear actuator using the switch on the actuator cover.

Automatic mode:

Slide the switch to position  .

Testing the safety function:

Slide the switch to position  .

When the “safety function test” feature is activated, the extended indicator slide allows this status to be recognized even in poorly lit areas.

After the “safety function test” has been switched off, the linear actuator automatically returns to automatic mode.

### Position indicator on the linear actuator

The current stroke position of the valve is indicated by the position of the stroke range scale (3).



### Automatic malfunction message

If the valve stroke is blocked by the presence of foreign objects in the pipeline, the linear actuator reports this malfunction with a feedback signal approx. >DC 12.5 V (terminal A). The LED below the actuator cover also flashes (short flashes).

The linear actuator then automatically tries to correct the valve block using a remedy algorithm, which repeatedly lifts the valve cone for a short time.

A manual activation of the safety function or manual adjustment is also signaled by a feedback signal of approx. > DC 12.5 V.

**Zero crossing**

The economical three-wire connection combines the zero potentials of control line Y (direct current) and of the power line (alternating current) into one wire. The Y control signal is processed by software to reduce errors in the Y control signal caused by voltage drops arising from very long cable lengths.

**Run time lag after mains power recovery**

After power has been lost for a longer time, the linear actuator moves out of the safety position to the current nominal position with reduced positioning speed. When the current control position is reached, it is switched over to the positioning speed that is set.

This prevents oscillations in steam systems and monitoring from being triggered when power is recovered.

**Installation****WARNING****Warning: Mains voltage AC 230 V.**

Electrical installation and unit connection may only be carried out by qualified technicians.

The mains supply may only be connected after the electrical installation.

Be sure to comply with VDE guidelines and local wiring regulations.

The device is connected according to the obligatory wiring diagram.

**CAUTION****The electrical connection of the linear actuator must be carried out as a fixed installation.**

An M16 x 1.5 screw fitting (included in the scope of delivery of the linear actuator) is to be used as a strain relief device. The electrical connection is to be made using plug-in screw terminals (connection diameter 0.3 mm to 2.3 mm). Cables between the low voltage (AC 230 V) lines and the other lines (e.g. positioning feedback connection) must be routed separately. This requires an additional M20 x 1.5 screw fitting (not included in the scope of delivery).

**CAUTION****There is a risk of getting crushed between the cross member and the spring pan.**

The safety function of the linear actuator automatically moves the valve into the upper end position using high spring force when the power supply is interrupted.

**Product Description**

**MC100FSR/230**

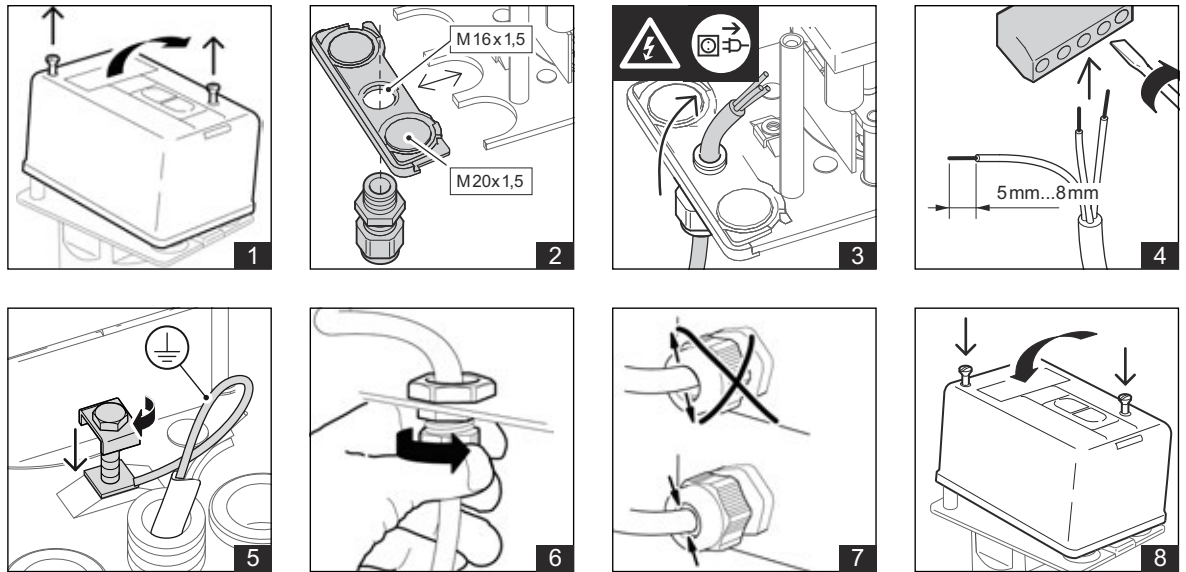

**Direct control/priority switching**

Priority switching can be used parallel to the energized 3-point control by wiring the Z2 and Z3 terminals. Control of the linear actuator replaces regular control from the loop controller via terminals 2 and 3.

Note the following priorities for priority switching:

Priority	Terminal Z2	Terminal Z3	Linear actuator
None	Open	Open	Priority switching not functioning. Control is evaluated via terminals 2 and 3.
Medium	Closed	Open	Linear actuator moves into the lower end position.
	Open	Closed	Linear actuator moves into the upper end position.
High	Closed	Closed	Linear actuator moves into the upper end position.

## Valve Installation



### CAUTION

The valve may only be installed by qualified technicians. In addition to the generally valid installation guidelines, the following points are to be observed:

- The valve gates come with protective caps to protect against contamination. They are to be removed before installing the valves.
- The pipeline system and the interior of the fixture must be free of foreign objects. In the event of contaminated media, dirt collectors are to be inserted upstream of the valves.
- There must be no tension between the fixture and the pipeline connection.
- Use only perfectly fitting flange seals, inserted centrally in the valve flanges.
- To avoid eddy formations in the valve body, the valve should be installed in a straight section of the pipe. A distance of 10 times the nominal diameter is recommended between the valve flange and manifold or other similar parts.
- The installation location is to be selected so that the ambient temperature at the linear actuator is kept between 0 °C and +50 °C.
- When the valve is being installed, the permissible max. pressure difference  $\Delta p$  and the specified flow direction are to be observed.
- The linear actuator can be installed vertically above the fixture, or in any position as far as a horizontal position. When installed horizontally, the drive pillars must be one upon the other. Where applicable, turn the cross member after loosening the retaining nut.
- To remove the linear actuator cover, approx. 100 mm of free space is required above the actuator.
- The linear actuator is delivered with a protective box. Up until commissioning, this cover protects the linear actuator during the installation phase and pipeline work.
- Observe the direction of flow arrow on the valve body. Inverting the direction of flow impairs control behavior.



Mounting

Installation instructions

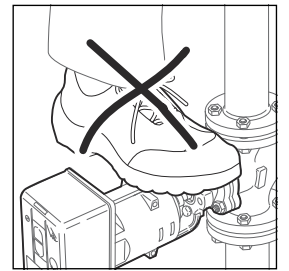
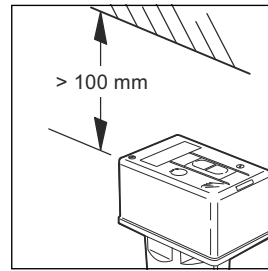
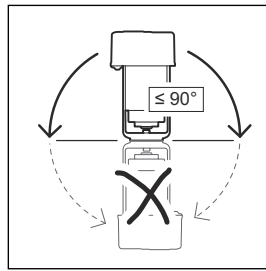
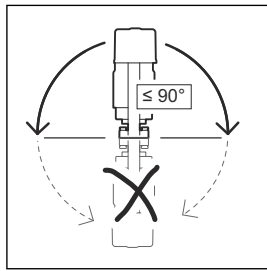

Mounting and installation

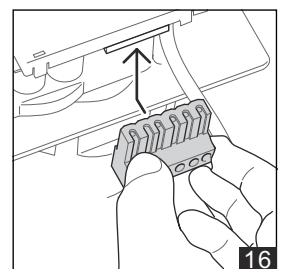
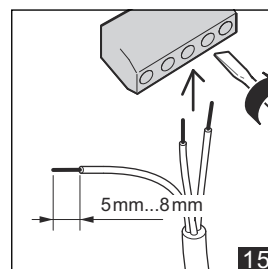
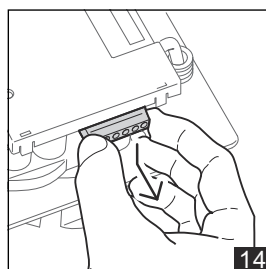
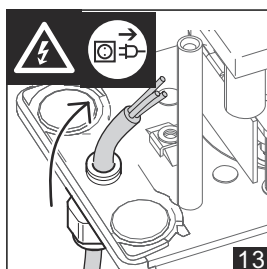
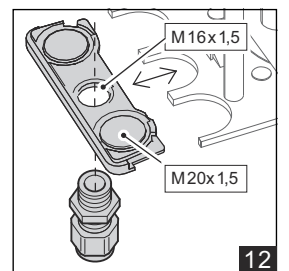
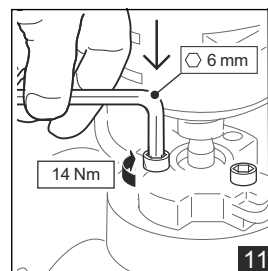
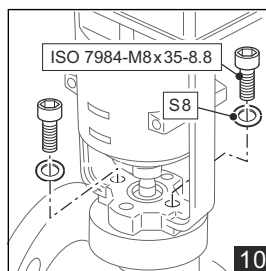
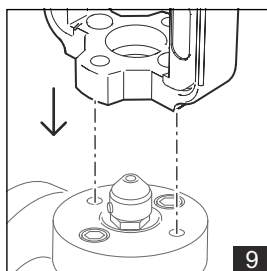
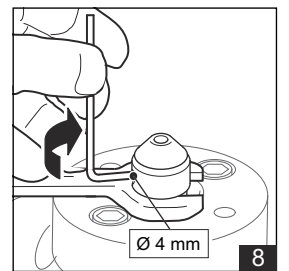
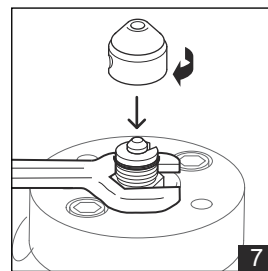
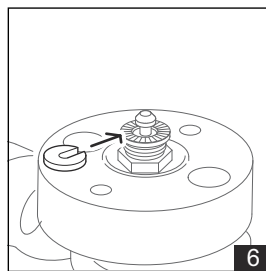
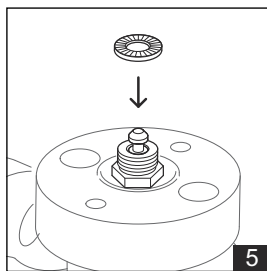
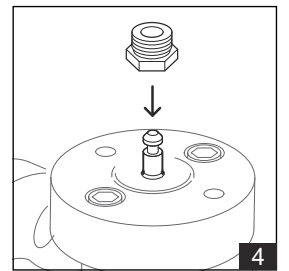
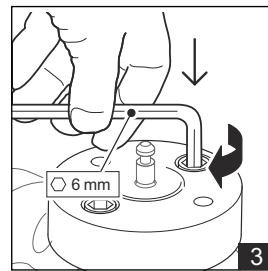
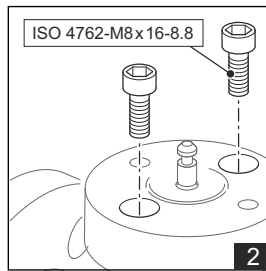
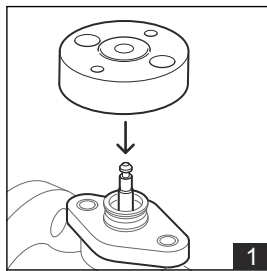

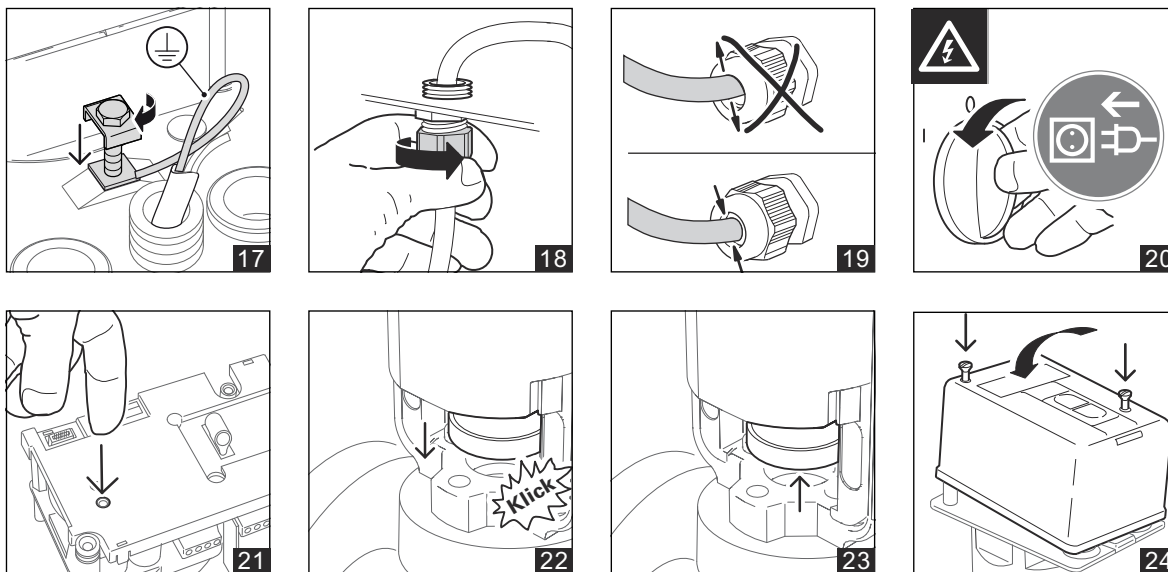

- If the valve is installed in the plant, ensure that no differential pressure builds up in the valve body before beginning work. If necessary, close the gate valve and switch off pumps.
- After the pipeline has cooled off, you can begin installation of the linear actuator.
- Once the linear actuator has been mounted and installed, you must trigger an automatic initialization run, see “Commissioning Steps”.



#### CAUTION

Both hexagon socket screws must be tightened equally with the hexagon socket key (see Fig. 8).

Product Description

MC100FSR/230

Removal

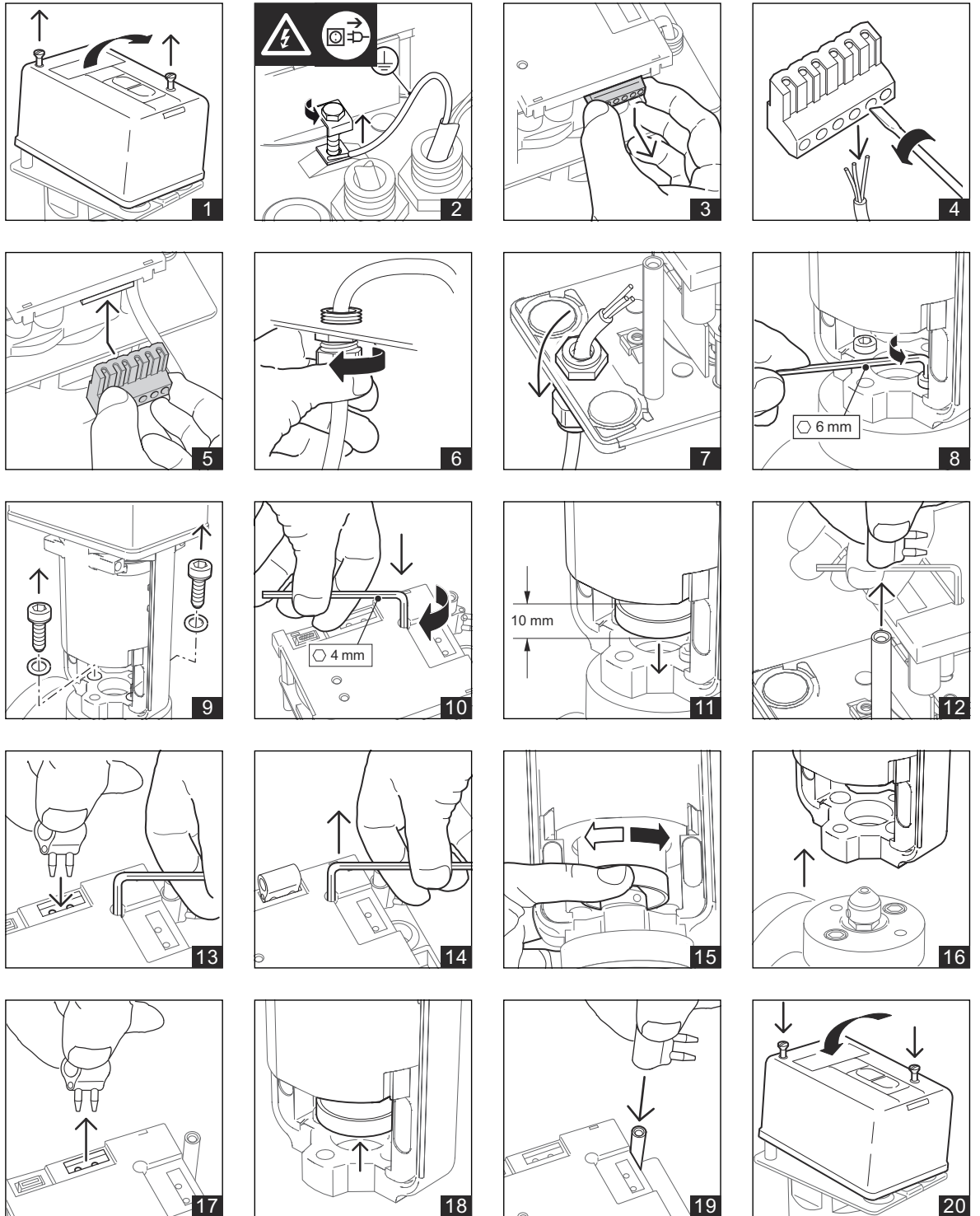

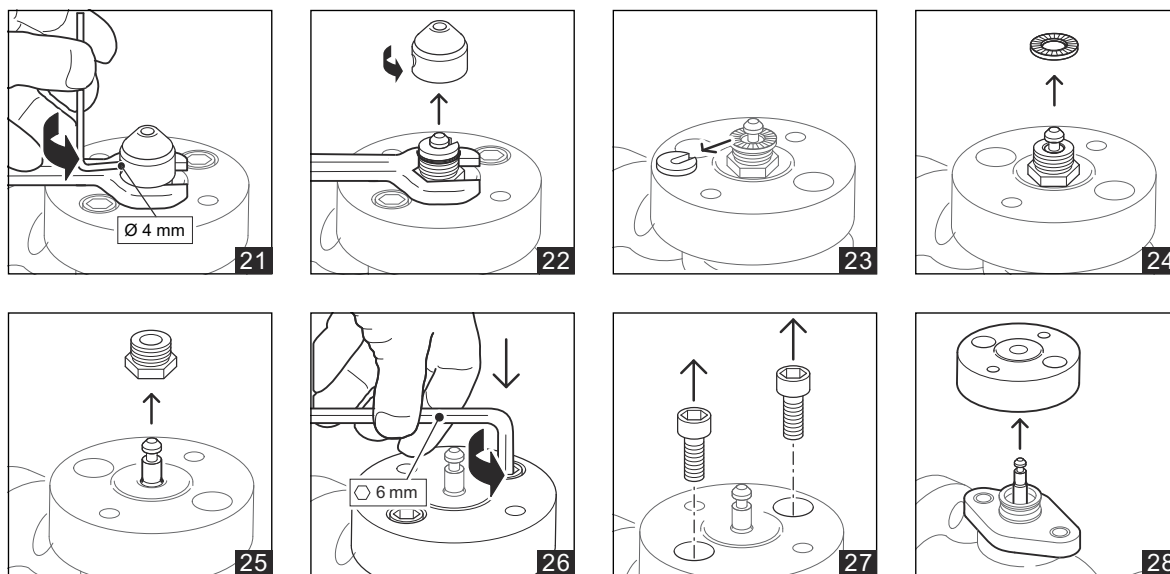

- Before beginning to remove the unit, make sure that no differential pressure builds up in the valve body before beginning work. If necessary, close the gate valve and switch off the pumps. After the pipeline has cooled off, you can begin removal of the linear actuator.
- Disconnect the linear actuator from the mains power supply. Then disconnect all electrical connections.

**Commissioning**

Operating and functional components beneath the linear actuator cover

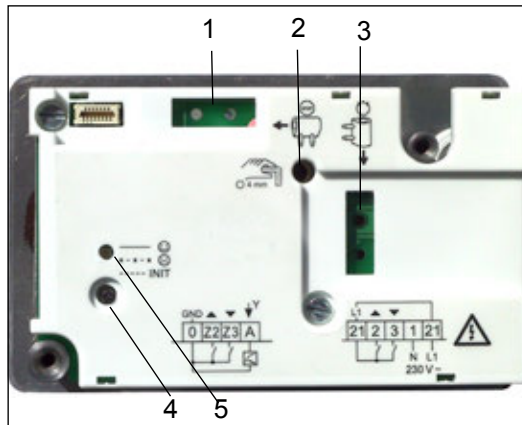

- (1) Receptacle for the knob during manual adjustment
- (2) Socket for hexagon socket key
- (3) Receptacle for the knob during automatic mode without cover during commissioning
- (4) INIT button
- (5) Status LED display

**General Information**

The commissioning process may change if accessories are installed. In such cases, commissioning is described in the data sheet of the accessory that is being used.



**CAUTION**

Automatic mode without the cover may only be used by the technician during commissioning.

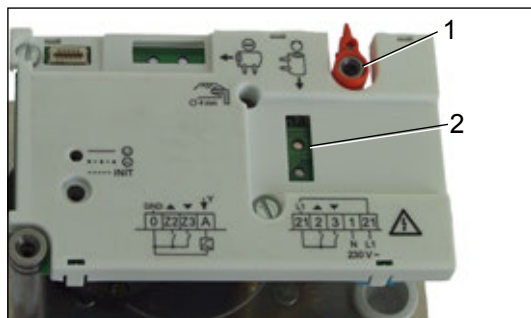

Knob not inserted = safety function triggered

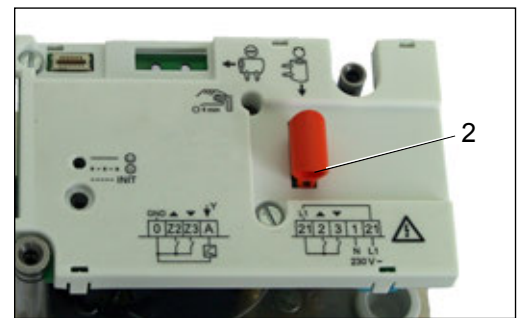

Knob inserted = automatic mode

When the cover is removed, the linear actuator automatically tests the safety function and moves into its safety position to maintain safe operation. To allow the commissioning technician to test for proper function, the linear actuator can be switched to automatic mode by inserting the knob (1).

Remove the actuator cover and then insert the knob (1) into the PCB (2).



**CAUTION**

**Observe after installing the linear actuator.**

If the linear actuator was installed on-site, the nominal stroke must be adjusted to the valve stroke using initialization (INIT).

**Status of the LED displays**

LED beneath the linear actuator cover	Meaning
Permanent light	Normal operation
Short flashes	Disabled state / voltage polarity incorrect
Long flashes	Initialization run

**Commissioning Steps**

**1. Testing for proper actuating device installation and testing the electrical connection**

**2. Switching on the power supply**

LED (2) flashes.



**NOTE**

In the first 10 min after switching on the supply voltage, positioning movements are carried out separately from the normal operating characteristics with idle periods of approx. 2 s.

**3 Initialization and adjustment to the valve stroke**

Remove the actuator cover and then insert the knob (3) into the PCB (see diagram).

The initialization run is switched on by pressing the INIT button (1). The valve is completely opened and closed once during initialization. LED (2) flashes during initialization. The linear actuator always moves first to the upper end position and then to the lower end position.

The LED remains constantly lit to signal that initialization is completed.

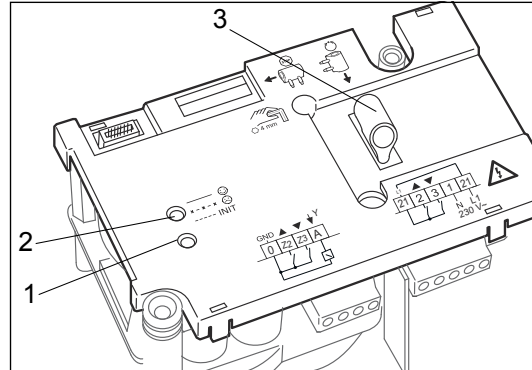

**4 Position feedback**

At terminal "A", a constant DC 0 to 10 V signal can be picked up for

- position feedback (=display of current position of the linear actuator) or
- reporting an error status/manual mode (approx. > DC 12.5 V)

**5 Manual adjustment**

Remove the linear actuator cover for manual operation. Using a hex key (key socket 4 mm), the valve can be moved into any position. The knob is then used to lock the linear actuator. See "Installing the Linear Actuator".

**6 Accessories**

If additional components are installed on the linear actuator (see accessories), their functionality must be tested and adjusted as necessary.

**You must follow the accessories' descriptions with connection instructions when doing so.**

**7 Function test**

Replace and tighten the screws of the linear actuator cover after the drive settings have been made with any accessories.

Then test the complete functionality of the actuator in the control system, including the safety function.

