

IMI Heimeier

TA-COMFORT Fußbodenheizungs-Station / Radiant Heating Interface Unit Dynacon Eclipse

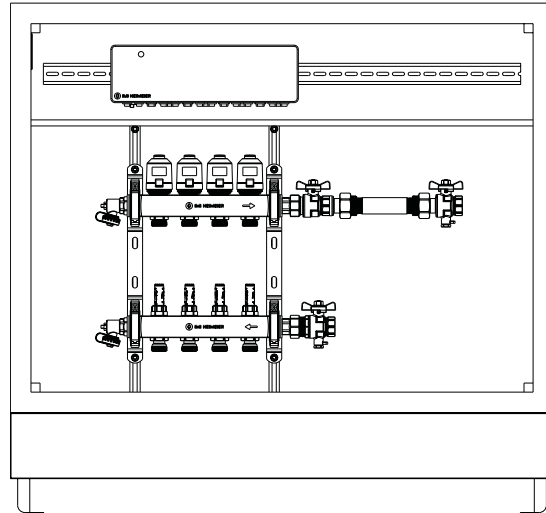

- 2
- 3
- 4
- 5
- 6
- 7
- 8
- 9
- 10
- 11
- 12

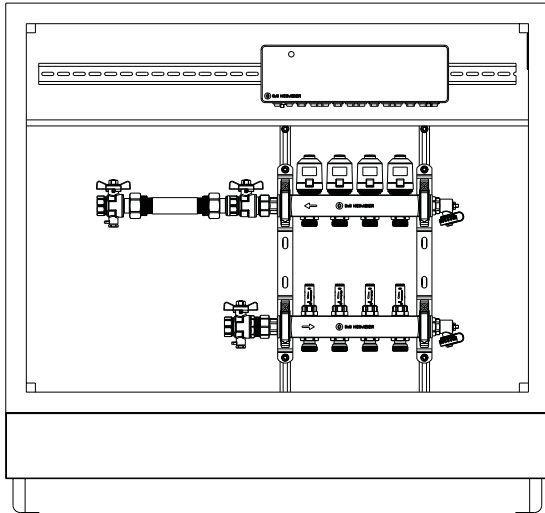
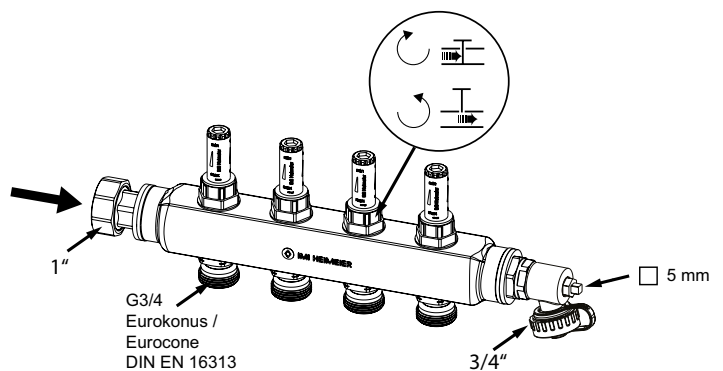
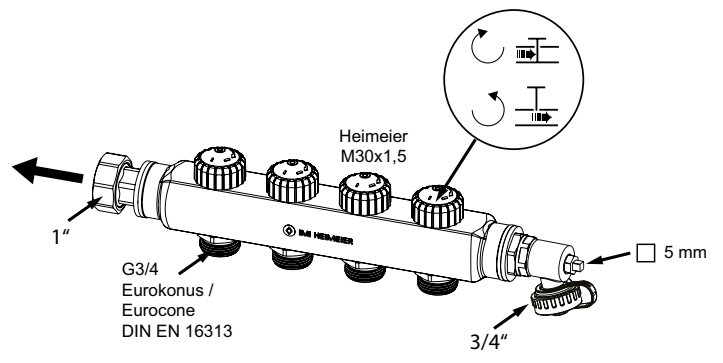
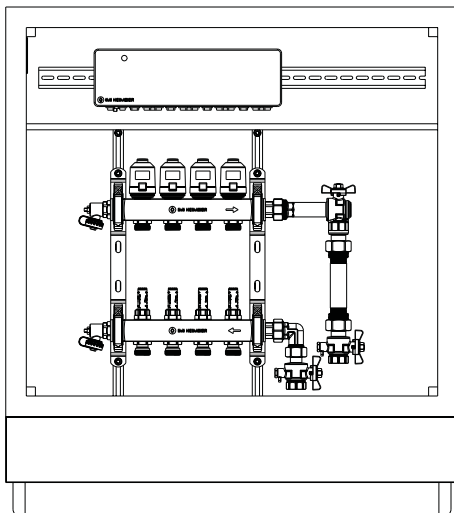
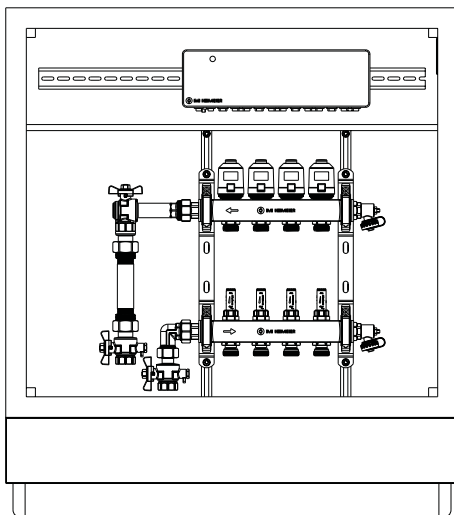

Heimeier:
Kupfer / Copper
Kunststoff / Plastic
Alu/Pex

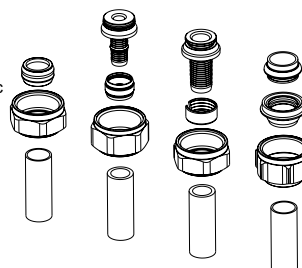

Gedruckt auf chlorfrei gebleichtem Papier.

We reserve the right to introduce technical alterations without previous notice.

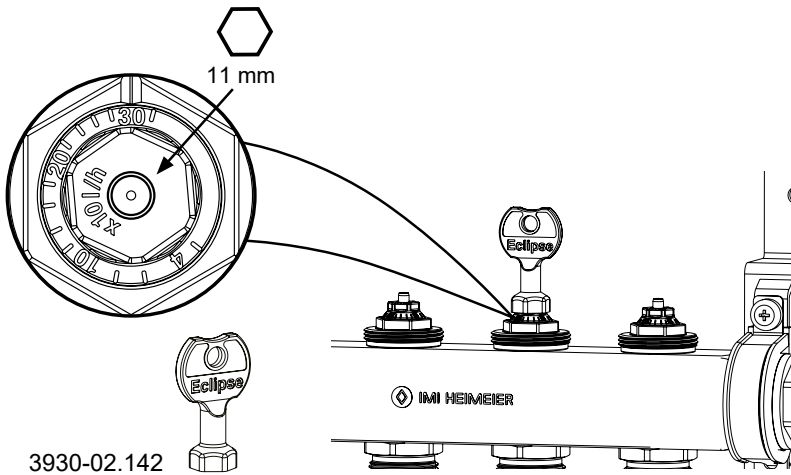
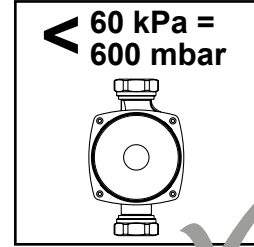
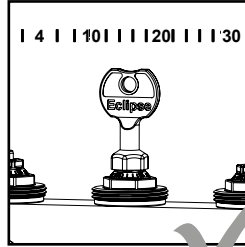
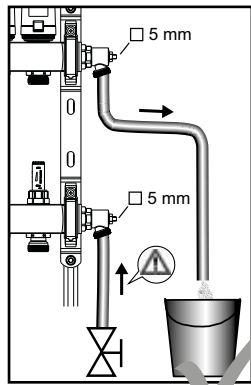

Auto.

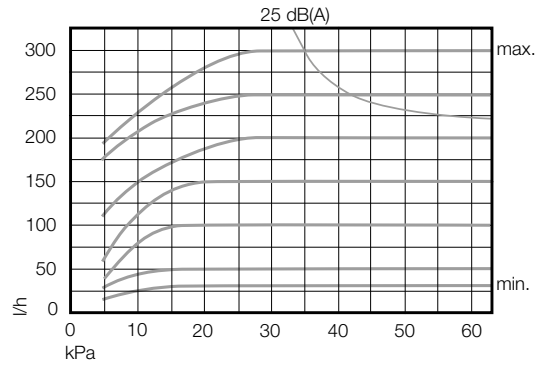

3930-02.142

		4			10					20				30	
l/h	30	40	60	80	100	120	140	160	180	200	220	240	260	280	300

Q [W]	200	250	300	400	500	600	700	800	900	1000	1200	1400	1600	1800	2000	2200	2400	2600	2800	3000	3200	3400	3600	3800	4000	4800	5200	
Δt [K]																												
5	3	4	5	7	9	10	12	14	16	17	21	24	28															
8			3	4	5	7	8	9	10	11	13	15	17	19	22	24	26	28										
10				3	4	5	6	7	8	9	10	12	14	16	17	19	21	22	24	26	28	29						
15					3	3	4	5	5	6	7	8	9	10	12	13	14	15	16	17	18	20	21	22	23	28	30	

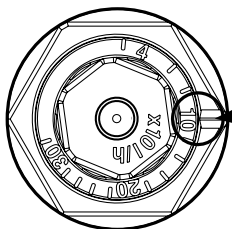

Δp min. 30 - 150 l/h = 17 kPa
 Δp min. 150 - 300 l/h = 25 kPa

We reserve the right to introduce technical alterations without previous notice.