

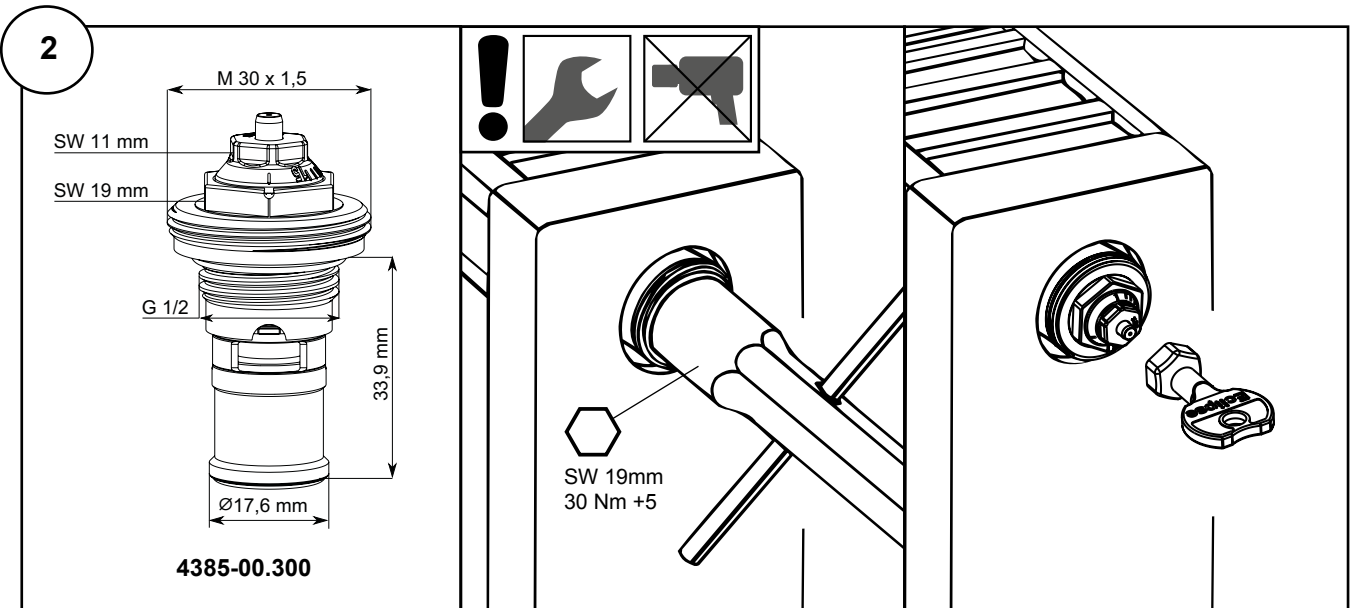

# Eclipse - 4385-00.300

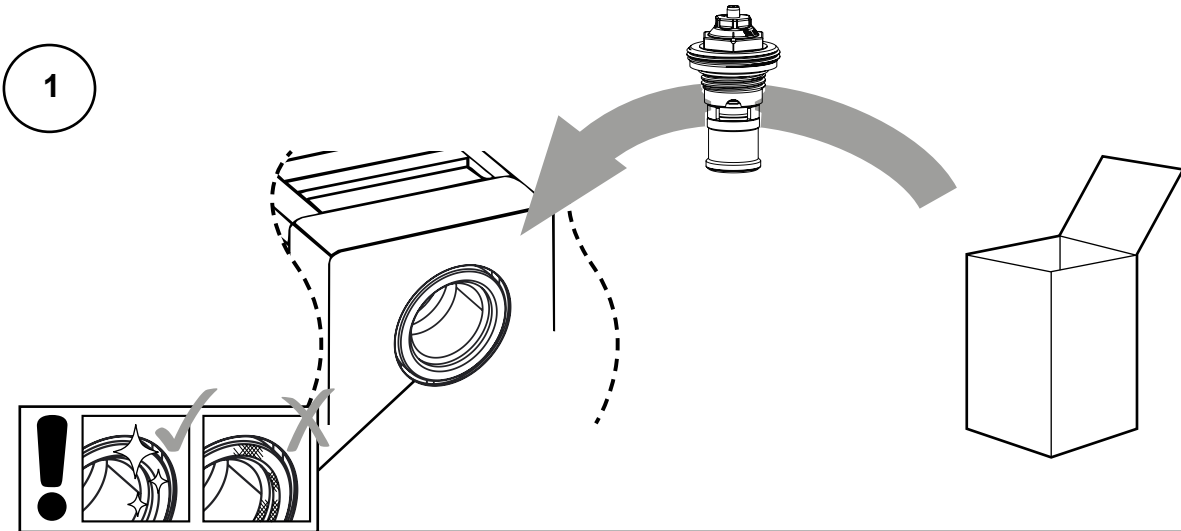



Gedruckt auf chlorfrei gebleichtem Papier.

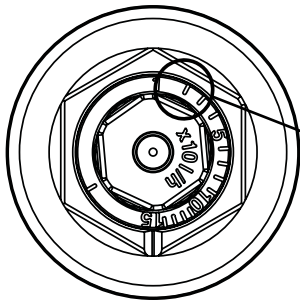
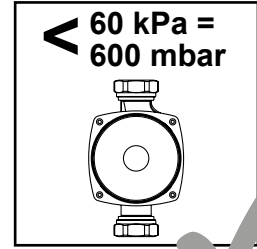
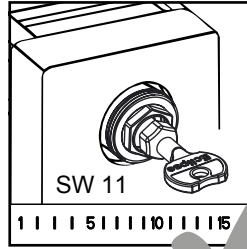
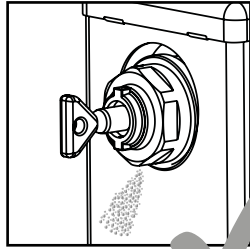

3930-02.142

We reserve the right to introduce technical alterations without previous notice.



	1	1	1	1	5	1	1	1	1	10	1	1	1	1	15			
l/h	10	20	30	40	50	60	70	80	90	100	110	120	130	140	150			
Q̇ [W]	200	250	300	400	500	600	700	800	900	1000	1200	1400	1600	1800	2000	2200	2400	2600
Δt [K]	l/h																	
5	3	4	5	7	9	10	12	14										
8	2	3	3	4	5	7	8	9	10	11	13	15						
10	2	2	3	3	4	5	6	7	8	9	10	12	14					
15	1	1	2	2	3	3	4	5	5	6	7	8	9	10	12	13	14	15

Δp min. 10 - 100 l/h = 10 kPa

Δp min. 100 - 150 l/h = 15 kPa

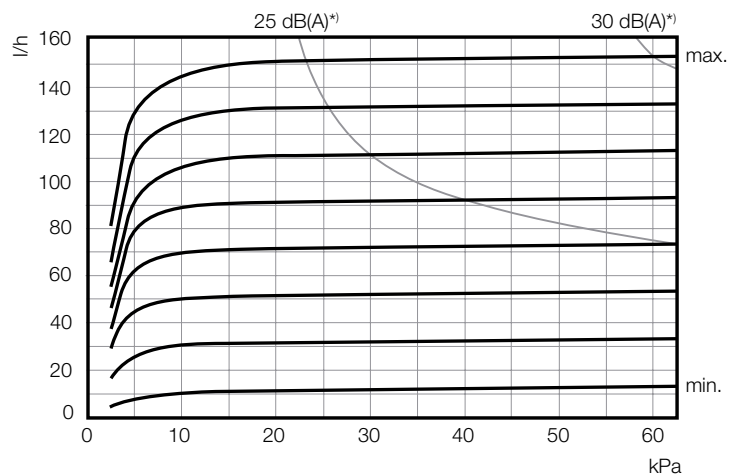

We reserve the right to introduce technical alterations without previous notice.