

Statico



Expansion vessels with fixed air cushion

From 8 L to 5000 L

Statico

The Statico range features pressure expansion vessels with fixed gas charge for heating, solar and cooling water systems. A brilliantly simple design, robust construction and operation without auxiliary power make them among the most sought-after pressure maintenance devices in the lower performance range.



Key features

- > **Airproof butyl bag according to EN 13831**
- > **Wide range of vessel sizes for different system needs**
From 8 L to 5000 L
- > **Brilliantly simple, robust design**
Operation without auxiliary power.
- > **Excellent elasticity**
Thanks to the fixed gas cushion.

Technical description

Applications:

Heating, solar and chilled water systems.

Media:

Non-aggressive and non-toxic system media.
Addition of antifreeze agent up to 50%.

Pressure:

Min. admissible pressure, PSmin: 0 bar
Max. admissible pressure, PS: see Articles

Temperature:

Max. admissible bag temperature, TB: 70 °C

Min. admissible bag temperature, TBmin: 5 °C

For PED purposes:

Max. admissible temperature, TS: 120°C

Min. admissible temperature, TSmin: -10°C

Material:

Steel. Color beryllium.
Lock shield valve DLV: Brass

Transportation and storage:

In frostless, dry places.

Standard:

Constructed according to PED 2014/68/EU.

Warranty:

Statico SD, SU: 5-year warranty for the vessel.

Statico SG: 5-year warranty for the airproof butyl bag.

Function, Equipment, Features

- Airproof butyl bag according to EN 13831 and PNEUMATEX internal standards.
- Airproof butyl bag according to EN 13831, and PNEUMATEX internal standards, exchangeable (SG).
- Feet for upright assembly (SU, SG). Wall bracket for easy assembly (SD).
- Installation with bottom, side or top connection. From 80 litres with bottom or side connection (SD).

Calculation

Pressure maintenance for systems TAZ ≤ 100°C

Calculation following EN 12828, SWKI HE301-01.

For all special applications such as solar systems, district heating systems, systems with temperatures above 100°C or cooling systems with temperatures below 5°C please use HySelect software or contact us.

General equations

Vs	Water capacity of the system	Heating	Vs = vs · Q	vs Q	Specific water capacity, table 4. Installed heat capacity
			Vs = Known		System design, content calculation
		Cooling	Vs = Known		System design, content calculation
Ve	Expansion volume	EN 12828	Ve = e · (Vs + Vhs)	e, ehs	Expansion coefficient for $t_{s_{max}}$, table 1
		Cooling	Ve = e · (Vs + Vhs)	e, ehs	Expansion coefficient for $t_{s_{max}}$, table 1 ⁷⁾
		SWKI HE301-01 heating	Ve = e · Vs · X ¹⁾ + ehs · Vhs	e ehs	Expansion coefficient for $(t_{s_{max}} + tr) / 2$, table 1 Expansion coefficient for $t_{s_{max}}$, table 1
		SWKI HE301-01 cooling	Ve = e · Vs · X ¹⁾ + ehs · Vhs	e, ehs	Expansion coefficient for $t_{s_{max}}$, table 1 ⁷⁾
Vwr	Water reserve	EN 12828, Cooling	Vwr ≥ 0,005 · Vs ≥ 3 L		
		SWKI HE301-01	Vwr is considered in Ve with the coefficient X		
p0	Minimum pressure ²⁾ Lower limit value for the pressure maintenance	EN 12828, Cooling	p0 = Hst/10 + 0,2 bar ≥ pz	Hst	Static height
		SWKI HE301-01	p0 = Hst/10 + 0.3 bar ≥ pz	pz	Minimum required equipment pressure for pumps or boilers
pa	Initial pressure Lower threshold for an optimum pressure maintenance		pa ≥ p0 + 0,3 bar		
pe	Final pressure Upper threshold for an optimum pressure maintenance.			psvs dpsvs _c	Response pressure safety valve system Closing pressure tolerance of the safety valve
		EN 12828	pe ≤ psvs - dpsvs_c	dpsvs _c dpsvs _c	= 0,5 bar for psvs ≤ 5 bar ⁴⁾ = 0,1 · psvs for psvs > 5 bar ⁴⁾
		cooling	pe ≤ psvs - dpsvs_c	dpsvs _c dpsvs _c	= 0,6 bar for psvs ≤ 3 bar ⁴⁾ = 0,2 · psvs for psvs > 3 bar ⁴⁾
		SWKI HE301-01 heating	pe ≤ psvs/1.3 pe ≤ psvs/1.15		for psvs ≤ 3 bar ⁴⁾ for psvs > 3 bar ⁴⁾
		SWKI HE301-01 cooling	pe ≤ psvs/1.3 and pe ≤ psvs - 0.6 bar		psvs ⁴⁾

Statico

PF	Pressure factor		PF = (pe + 1)/(pe - p0)		
VN	Nominal volume of the expansion vessel ⁵⁾	EN 12828, cooling	VN ≥ (Ve + Vwr + 2 ³⁾) · PF		
		SWKI HE301-01	VN ≥ (Ve + 2 ³⁾) · PF		

1) Heating, Cooling : Q ≤ 10 kW: X = 3 | 10 kW < Q ≤ 150 kW: X = (87-0,3 · Q)/28 | Q > 150 kW: X = 1,5
Geothermal probe systems: X = 2,5

2) The formula for minimum pressure p0 applies to the installation of pressure maintenance on the suction side of the circulation pump. In case of a pressure-side installation p0 is to be increased by the pump pressure Δp.

3) Add 2 litres when a Vento is installed in the system.

4) The safety valves must operate within these limits. Use component tested and certified safety valves of type H and DGH for heating systems, type F for cooling systems.

5) Please select a vessel with an equal or higher nominal volume.

7) Max. system standstill temperature, usually 40°C for cooling applications and geothermal probes with ground regeneration, 20°C for other geothermal probes

^{*)} SWKI HE301-01: Valid for Switzerland

HySelect calculation software is based on an advanced calculation method and database. Results may vary.

Table 1: e expansion coefficient

t (TAZ, ts _{max} , tr, ts _{min}), °C	20	30	40	50	60	70	80	90	100	105	110
e Water = 0 °C	0,0016	0,0041	0,0077	0,0119	0,0169	0,0226	0,0288	0,0357	0,0433	0,0472	0,0513
e % weight MEG*											
30 % = -14,5 °C	0,0093	0,0129	0,0169	0,0224	0,0286	0,0352	0,0422	0,0497	0,0577	0,0620	0,0663
40 % = -23,9 °C	0,0144	0,0189	0,0240	0,0300	0,0363	0,0432	0,0505	0,0582	0,0663	0,0706	0,0750
50 % = -35,6 °C	0,0198	0,0251	0,0307	0,0370	0,0437	0,0507	0,0581	0,0660	0,0742	0,0786	0,0830
e % weight MPG**											
30 % = -12,9 °C	0,0151	0,0207	0,0267	0,0333	0,0401	0,0476	0,0554	0,0639	0,0727	0,0774	0,0823
40 % = -20,9 °C	0,0211	0,0272	0,0338	0,0408	0,0481	0,0561	0,0644	0,0731	0,0826	0,0873	0,0924
50 % = -33,2 °C	0,0288	0,0355	0,0425	0,0500	0,0577	0,0660	0,0747	0,0839	0,0935	0,0985	0,1036

Table 4: vs approx. water capacity * of central heatings referred to the installed heat capacity Q**

ts _{max} tr °C		90 70	80 60	70 55	70 50	60 40	50 40	40 30	35 28
Radiators	vs liter/kW	14,0	16,5	20,1	20,6	27,9	36,6	-	-
Flat radiators	vs liter/kW	9,0	10,1	12,1	11,9	15,1	20,1	-	-
Convectors	vs liter/kW	6,5	7,0	8,4	7,9	9,6	13,4	-	-
Air handlers	vs liter/kW	5,8	6,1	7,2	6,6	7,6	10,8	-	-
Floor heating	vs liter/kW	10,3	11,4	13,3	13,1	15,8	20,3	29,1	37,8

*) MEG = Mono-Ethylene Glycol

**) MPG = Mono-Propylene Glycol

***) Water capacity = heat generator + distribution net + heat emitters

Table 5: DNe standard values for expansion pipes with Statico and Compresso

Length up to approx. 30 m	DNe	20	25	32	40	50	65	80
Heating:								
EN 12828	Q kW	1000	1700	3000	3900	6000	11000	15000
SWKI HE301-01	Q kW	300	600	900	1400	3000	6000	9000
Cooling:								
ts _{max} ≤ 50 °C	Q kW	1600	2700	4800	6300	9600	17600	24100

Temperatures

ts_{max}	Maximum system temperature Maximum temperature for the calculation of the volume expansion. For heating systems the dimensioned flow temperature at which a heating system is to be operated with the lowest outside temperature to be assumed (standard outside temperature according to EN 12828). For cooling systems the max. temperature that is achieved due to the operation mode or standstill, for solar systems the temperature up to which an evaporation is to be avoided.
ts_{min}	Lowest system temperature Lowest temperature for calculating expansion volumes. The lowest system temperature is equal to the freezing point. It is dependant on the percentage of antifreeze additives. For water without additives ts _{min} = 0.
tr	Return temperature Return temperature of the heating system with the lowest outside temperature to be assumed (standard outside temperature according to EN 12828).
TAZ	Safety temperature limiter Safety temperature controller Temperature limit Safety device according to EN 12828 for the temperature protection of heat generators. If the set temperature limit is exceeded the heating is turned off. Limiters are locked, controllers automatically release the heat supply if the set temperature falls short. Setting value for systems according to EN 12828 ≤ 110 °C.

Precision pressure maintenance

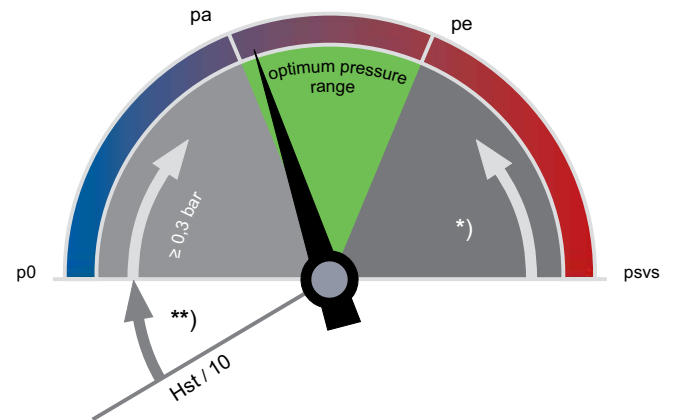

**)
EN 12828, Solar, Cooling: ≥ 0,2 bar
SWKI HE301-01: ≥ 0,3 bar

*)
EN 12828: ≥ psvs · 0,9 ≥ 0,5 bar
Solar, Cooling: ≥ psvs · 0,8 ≥ 0,6 bar
SWKI HE301-01 Heating, psvs ≤ 3 bar: ≥ psvs / 1,3
SWKI HE301-01 Heating, psvs > 3 bar: ≥ psvs / 1,15
SWKI HE301-01 Cooling: ≥ psvs / 1,3

p0 Minimum pressure

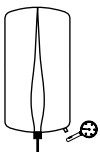

Statico

p0 is set as pre set pressure on the gas side.

pa Initial pressure

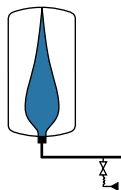

Statico

pa is the cold fill pressure which determines the water reserve:
pa ≥ p0 + 0,3 bar;
water make-up «on»: pa – 0,2 bar.

pe Final pressure

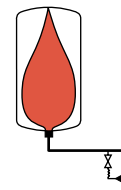

Statico

pe is reached after heating up to ts_{max}.

Quick selection

Heating systems TAZ ≤ 100°C, without addition of antifreeze, EN 12828.

For exact calculations please use HySelect software.

Q [kW]	psv = 2,5 bar			psv = <u>3,0</u> bar			psv = 3,0 bar		
	Hst ≤ 7 m ≥ p0 = 1,0 bar						Hst ≤ 12 m ≥ p0 = 1,5 bar		
	Radiators 90 70	Flat radiators 90 70	Flat radiators 70 50	Radiators 90 70	Flat radiators 90 70	Flat radiators 70 50	Radiators 90 70	Flat radiators 90 70	Flat radiators 70 50
	Nominal volume VN [liter]								
10	25	25	18	25	18	18	35	25	25
15	35	25	25	25	18	18	35	35	25
20	50	35	25	35	25	25	50	35	35
25	50	35	35	50	35	25	80	50	35
30	80	50	35	50	35	35	80	50	50
40	80	50	50	80	50	35	80	80	50
50	140	80	50	80	50	50	140	80	80
60	140	80	80	80	80	50	140	80	80
70	140	80	80	140	80	80	140	140	80
80	140	140	80	140	80	80	200	140	140
90	200	140	140	140	80	80	200	140	140
100	200	140	140	140	140	80	200	140	140
150	300	200	200	200	140	140	300	200	200
200	400	300	200	300	200	200	400	300	300
250	500	300	300	400	300	300	500	400	300
300	500	400	300	400	300	300	600	400	400
400	800	500	400	600	400	300	800	500	500
500	1000	600	500	800	500	400	1000	800	600
600	1000	800	600	800	500	500	1500	800	800
700	1500	800	800	1000	600	600	1500	1000	800
800	1500	1000	800	1500	800	600	1500	1000	1000
900	1500	1000	1000	1500	800	800	2000	1500	1000
1000	2000	1500	1000	1500	1000	800	2000	1500	1500
1500	3000	2000	1500	2000	1500	1500	3000	2000	2000

Example

Q = 200 kW
 psv = 3 bar
 Hst = 8 m
 Radiators 90 | 70 °C

Selected:

Statico SU 300.3
 p0 = 1 bar
 Reduce the factory set preset pressure from 1,5 bar to 1 bar!

Note for TAZ above 100 °C

Above 100°C the static height Hst decreases in the quick selection table.

TAZ = 105°C: Hst – 2 m

TAZ = 110°C: Hst – 4 m

Pre-set pressure setting p0

$p_0 = (Hst/10 + p_v) + 0,2$ bar

Recommended: $p_0 \geq 1$ bar

Filling pressure, initial pressure

$p_a \geq p_0 + 0,3$ with cold, but vented system

Equipment

Lock shield valve DLV

Secured lock shield valve with draining for expansion vessels according to EN 12828, DLV 20 up to VN 800 litres, DN 40 for VN 1000 – 5000 litres to be locally supplied.

Expansion pipe

According to table 5.

Pleno

Water make-up as pressure maintenance monitoring device according to EN 12828.

Conditions:

- Pleno PIX without pump: required fresh water pressure: $w \geq p_0 + 1,7 \mid p_w \leq 10 \text{ bar}$,
- Pleno PI 9 with pump: p_a Statico within the working pressure range dpu of the Pleno.

Vento

Degassing and central venting.

Conditions:

- p_e, p_a Statico within the working pressure range dpu of the Vento,
- V_s Vento $\geq V_s$ water capacity of the system.

Zeparo

Air vent Zeparo ZUT or ZUP at each high point for venting while filling and/or draining. Separator for dirt and magnetite in each system in the main return to the heat generator. If no central degassing (Vento V Connect) is installed a microbubble separator can be added in the main flow, before the circulation pump where possible.

The static height (H_{st_m} per the following table) above the microbubble separators must not be exceeded.

$t_{s_{max}} \mid ^\circ\text{C}$	90	80	70	60	50	40	30	20	10
$H_{st_m} \mid \text{m}$	15,0	13,4	11,7	10,0	8,4	6,7	5,0	3,3	1,7

Further accessories, product and selection details:

Datasheets *Pleno*, *Vento*, *Zeparo* and *Accessories*.

Installation

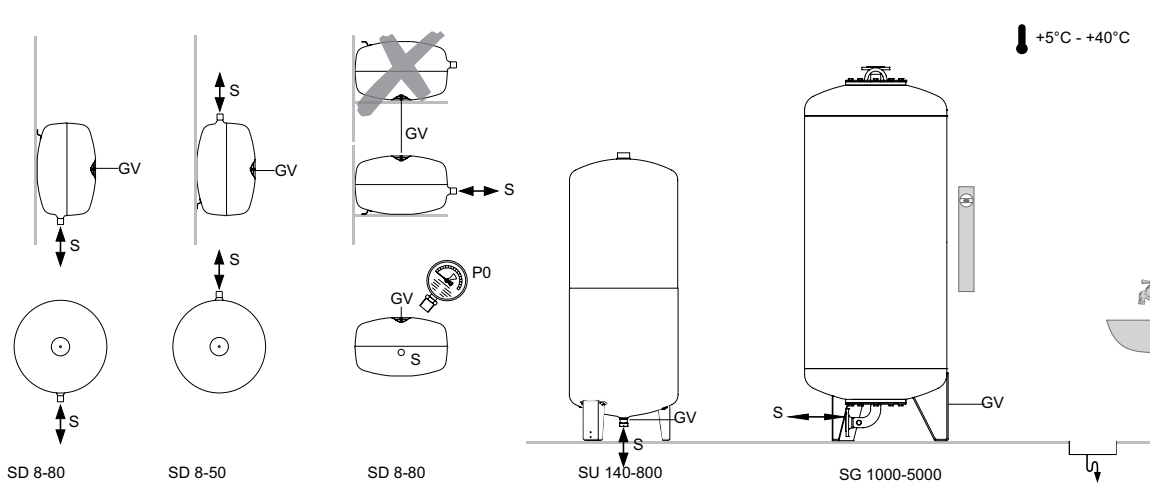

Application examples

Statico SD

For heating systems up to approx. 100 kW

(May require changes to meet local legislation)

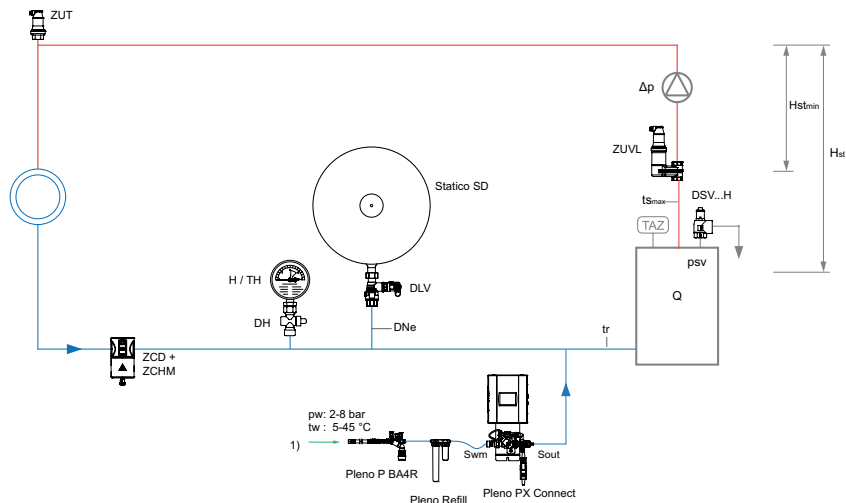

1) Water make-up connection

Pleno PIX water make-up as pressure maintenance monitoring device according to EN 12828.

Zeparo ZUV for the central separation of micro bubbles.

Zeparo Cyclone ZCDM cyclonic dirt separator with thermal insulation shells and magnets for the central capture of sludge and magnetite.

Zeparo ZUT for automatic venting during filling and during draining.

Further accessories, product and selection details: Datasheets Pleno, Zeparo and Accessories.

Statico SU

For heating system up to approx. 700 kW

(May require changes to meet local legislation)

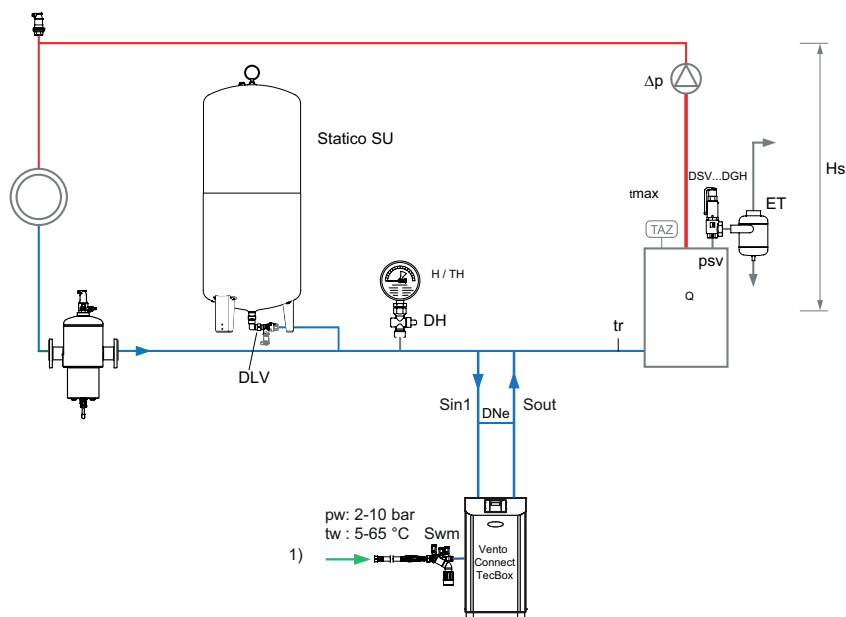

1) Water make-up connection

Vento Connect for the central venting and degassing, with water make-up as pressure maintenance monitoring device according to EN 12828.

Zeparo G-Force for the central separation of sludge.

Zeparo ZUT for automatic venting during filling and during draining.

Further accessories, product and selection details, see: Datasheet *Pleno*, *Zeparo* and *Accessories*.

Articles

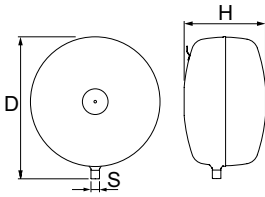

Statico SD

Discus shaped

Type	VN [l]	p0 [bar]	D	H	m [kg]	S	EAN	Article No
3 bar (PS)								
SD 8.3	8	1	314	166	3,5	R1/2	7640148630016	710 1000
SD 12.3	12	1	352	199	3,7	R1/2	7640148630023	710 1001
SD 18.3	18	1	393	222	4,1	R3/4	7640148630030	710 1002
SD 25.3	25	1	436	249	5	R3/4	7640148630047	710 1003
SD 35.3	35	1	485	280	6,4	R3/4	7640148630054	710 1004
SD 50.3	50	1,5	536	316	8	R3/4	7640148630061	710 1005
SD 80.3	80	1,5	636	346	12,7	R3/4	7640148630078	710 1006
10 bar (PS)								
SD 8.10	8	4	314	166**	4,0	R1/2	7640148630085	710 3000
SD 12.10	12	4	352	199**	5,1	R1/2	7640148630092	710 3001
SD 18.10	18	4	393	222**	6,5	R3/4	7640148630108	710 3002
SD 25.10	25	4	436	249**	8	R3/4	7640148630115	710 3003
SD 35.10	35	4	485	280**	9,7	R3/4	7640148630122	710 3004
SD 50.10	50	4	536	316**	12	R3/4	7640148630139	710 3005
SD 80.10	80	4	636	346**	16	R3/4	7640148630146	710 3006

VN = Nominal volume

***) Tolerance 0 /+35

Accessories:

Lock shield valve DLV

Intermediate vessel see datasheet Accessories

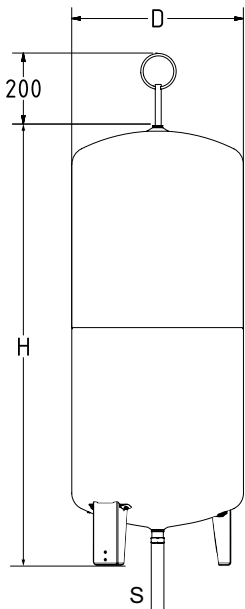

Statico SU

Slim, cylindrical model

Type	VN [l]	p0 [bar]	D	H	H***	m [kg]	S	EAN	Article No
3 bar (PS)									
SU 140.3	140	1,5	420	1274	1489	25	R3/4	7640148630153	710 1008
SU 200.3	200	1,5	500	1330	1565	32	R3/4	7640148630160	710 1010
SU 300.3	300	1,5	560	1451	1692	38	R3/4	7640148630177	710 1011
SU 400.3	400	1,5	620	1499	1760	56	R3/4	7640148630184	710 1012
SU 500.3	500	1,5	680	1588	1859	65	R3/4	7640148630191	710 1013
SU 600.3	600	1,5	740	1596	1874	75	R3/4	7640148630207	710 1014
SU 800.3	800	1,5	740	2090	2360	98	R3/4	7640148630214	710 1015
6 bar (PS)									
SU 140.6	140	3,5	420	1274	1489	25	R3/4	7640148630221	710 2008
SU 200.6	200	3,5	500	1330	1565	33	R3/4	7640148630238	710 2009
SU 300.6	300	3,5	560	1451	1692	39	R3/4	7640148630245	710 2010
SU 400.6	400	3,5	620	1499	1760	57	R3/4	7640148630252	710 2011
SU 500.6	500	3,5	680	1588	1859	66	R3/4	7640148630269	710 2012
SU 600.6	600	3,5	740	1596	1874	76	R3/4	7640148630276	710 2013
SU 800.6	800	3,5	740	2090	2360	100	R3/4	7640148630283	710 2014
10 bar (PS)									
SU 140.10	140	4	420	1274	1489	32	R3/4	7640148630290	710 3007
SU 200.10	200	4	500	1330	1565	40	R3/4	7640148630306	710 3008
SU 300.10	300	4	560	1451	1692	59	R3/4	7640148630313	710 3009
SU 400.10	400	4	620	1499	1760	70	R3/4	7640148630320	710 3010
SU 500.10	500	4	680	1588	1859	91	R3/4	7640148630337	710 3011

VN = Nominal volume

***) Max. height when vessel is tilted

Accessories:

Lock shield valve DLV

Intermediate vessel see datasheet Accessories

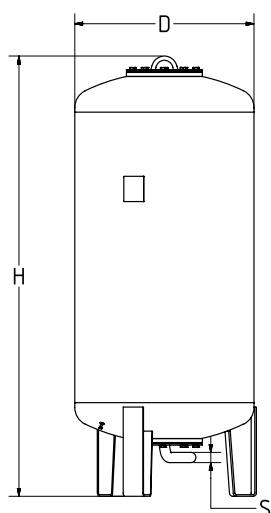
**Statico SG**

Slim, cylindrical model

Type*	VN [l]	p0 [bar]	D	H**	H***	m	S	EAN	Article No
6 bar (PS)									
SG 1000.6	1000	3,5	850	2089	2130	290	R1 1/2	7640148630351	710 2015
SG 1500.6	1500	3,5	1016	2248	2295	400	R1 1/2	7640148630368	710 2016
SG 2000.6	2000	3,5	1016	2738	2793	680	R1 1/2	7640148630375	710 2021
SG 3000.6	3000	3,5	1300	2850	2936	840	R1 1/2	7640148630382	710 2018
SG 4000.6	4000	3,5	1300	3496	3547	950	R1 1/2	7640148630399	710 2019
SG 5000.6	5000	3,5	1300	4140	4188	1050	R1 1/2	7640148630405	710 2020
10 bar (PS)									
SG 1000.10	1000	4	850	2092	2133	340	R1 1/2	7640148630412	710 3013
SG 1500.10	1500	4	1016	2277	2329	460	R1 1/2	7640148630429	710 3014
SG 2000.10	2000	4	1016	2774	2819	760	R1 1/2	7640148630436	710 3019
SG 3000.10	3000	4	1300	2873	2956	920	R1 1/2	7640148630443	710 3016
SG 4000.10	4000	4	1300	3518	3580	1060	R1 1/2	7640148630450	710 3017
SG 5000.10	5000	4	1300	4169	4211	1180	R1 1/2	7640148630467	710 3018

VN = Nominal volume

*) Applications > 10 bar and special vessels upon request.

**) Tolerance 0 /-100.

***) Max. height when vessel is tilted

Accessories: Intermediate vessel - see datasheet

Accessories for pressure maintenance

Technical description – Lock shield valve

Applications:

Heating, solar and cooling water systems. Deployment in systems according to EN 12828, SWKI HE301-01.

Media:Non-aggressive and non-toxic system media.
Addition of antifreeze agent up to 50%.**Functions:**

Shut-off. Maintenance and disassembly of expansion vessels.

Pressure:

Min. admissible pressure, PSmin: 0 bar

Max. admissible pressure, PS: 16 bar

Temperature:

Max. admissible temperature, TS: 120 °C

Min. admissible temperature, TSmin: -10 °C

Material:

Brass.

General:

Can only be closed with the supplied allen key. Ball valve with DN 15 hose connection for fast draining.

Lock shield valve

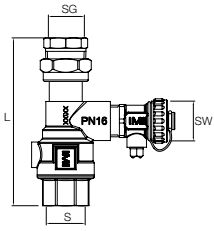

Lock shield valve DLV

Female thread on both sides, screw connection on the vessel connection side.

Type	PS [bar]	L	m [kg]	S	SG	SW	EAN	Article No
DLV 15	16	114	0,53	Rp3/4	Rp1/2	G3/4	7640148638562	535 1432

For SD vessels 8 and 12 l

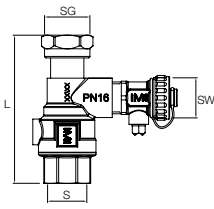

Lock shield valve DLV

Female thread on both sides, flat sealing union for direct connection to all suitable expansion vessels.

Type	PS [bar]	L	m [kg]	S	SG	SW	EAN	Article No
DLV 20	16	97	0,49	Rp3/4	G3/4	G3/4	7640148638579	535 1434
DLV 25	16	100	0,54	Rp1	G1	G3/4	7640148638586	535 1436

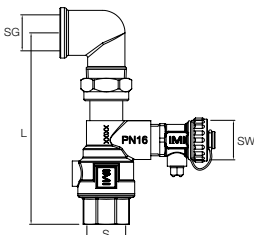

Connection set DLV A

Female thread on both sides, 90° bend with threaded seal for direct connection to Statico SU expansion vessels.

Type	PS [bar]	L	m [kg]	S	SG	SW	EAN	Article No
DLV 20 A	16	130	0,61	Rp3/4	Rp3/4	G3/4	7640148639842	746 2000
DLV 25 A	16	138	0,71	Rp1	Rp1	G3/4	7640161637214	301010-50601

Technical description – Manometer

Applications:

Heating, solar and cooling water systems. Deployment in systems according to EN 12828, SWKI HE301-01.

Pressure:

Min. admissible pressure, PSmin: 0 bar
Max. admissible pressure, PS: 4 bar

Functions:

Control of the filling pressure at expansion vessels.

Temperature:

Max. admissible temperature, TS: 60 °C
Min. admissible temperature, TSmin: -10 °C

Manometer

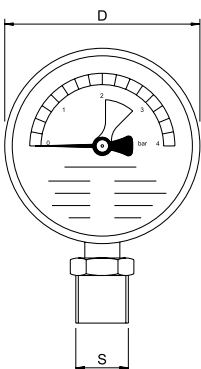

Manometer H

Display range 0-4 bar, with marked green pressure bandwidth for working pressure. Bottom connection.

Type	PS [bar]	D	m [kg]	S	EAN	Article No
H4	4	80	0,3	R1/2	7640148638616	501 1037

Technical description – Thermometer/Manometer

Applications:

Heating, solar and cooling water systems. Deployment in systems according to EN 12828, SWKI HE301-01.

Functions:

Control of the filling pressure at expansion vessels.

Pressure:

Min. admissible pressure, PSmin: 0 bar
Max. admissible pressure, PS: 4 bar

Temperature:

Max. admissible temperature, TS: 120 °C
Min. admissible temperature, TSmin: -10 °C

Thermometer/Manometer

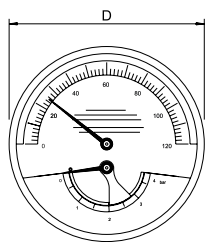

Thermometer/Manometer TH

Pressure display range 0-4 bar, temperature display range 0-120 °C, with marked green pressure bandwidth for working pressure.
Rear connection.

Type	PS [bar]	D	m [kg]	S	EAN	Article No
TH4	4	80	0,3	R1/2	7640148638623	501 1038

Technical description – Pre-pressure measuring gauge

Applications:

Heating, solar and cooling water systems. Deployment in systems according to EN 12828, SWKI HE301-01.

Functions:

Control of the pre-pressure at expansion vessels. Auto on/off. Automatic calibration.

Pressure:

Min. admissible pressure, PSmin: 0 bar
Max. admissible pressure, PS: 10 bar

Temperature:

Max. admissible temperature, TS: 120 °C
Min. admissible temperature, TSmin: -10 °C

Material:

Rugged plastic housing.

Pre-pressure measuring gauge



Pre-pressure measuring gauge DME

Type	PS [bar]	m [kg]	EAN	Article No
DME	10	0,3	7640148638593	500 1048

The products, texts, photographs, graphics and diagrams in this document may be subject to alteration by IMI Hydronic Engineering without prior notice or reasons being given. For the most up to date information about our products and specifications, please visit www.imi-hydronic.com.