

Regulux

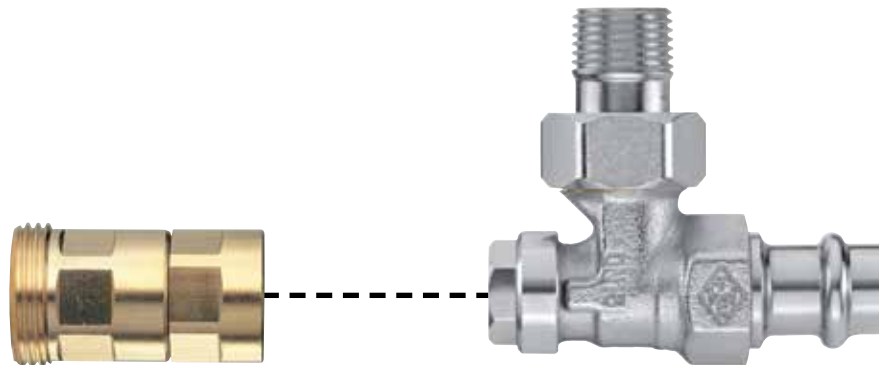

Return Lockshield

With consistent presetting and drain-off facility

Regulux

The Regulux is used in warm water pump heating systems and air conditioning systems. It makes possible the individual shut-off, drain-off and filling of e.g. of radiators in order to carry out painting or maintenance work, without having to shut down other radiators. The presetting cone which is integrated into the shut-off cone makes a hydraulic balance possible through presetting.



Technical description

Applications:

Heating and cooling systems.

Function:

Consistent presetting
Shut-off
Drain
Filling

Dimensions:

DN 10-20

Pressure class:

PN 10

Temperature:

Max. working temperature: 120°C, with
press connection 110°C.

Min. working temperature: -10°C.

Materials:

Valve body: Corrosion-resistant gunmetal
Valve insert: Brass
Spindles: Brass
O-rings: EPDM

Surface treatment:

Valve body and fittings are nickel-plated.

Marking:

THE, DN

Standards:

Length according to DIN 3842-1.

Pipe connection:

The female-threaded version is designed for connection to threaded pipe, or in conjunction with compression fittings, to copper precision steel or multi-layer pipe (only DN 15). The male-threaded version, in conjunction with the appropriate compression fittings, permits connection to plastic pipe. Versions with Viega press connection (15 mm) with SC-Contur are suitable for copper, Viega Sanpress stainless-steel, and Prestabo steel pipe.

Construction

Regulux

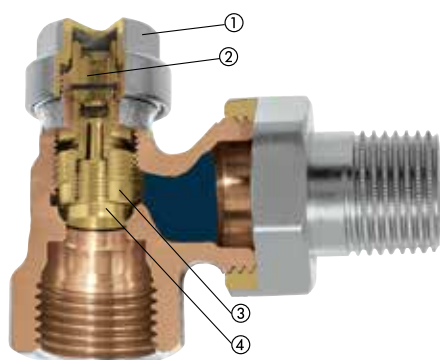

1. Closing cap
2. Thrust piece
3. Shut-off cone
4. Presetting cone

Application

The Regulux lockshield is used in warm water pump heating systems and air conditioning systems. Versions with female thread from DN 10 to DN 20, male thread G3/4 / DN 15 and Viega press connection 15 mm / DN 15 in angle and straight form make the threaded connection suitable for versatile and varied applications.

It makes possible the individual shut-off, drain-off and filling of e. g. of radiators in order to carry out painting or maintenance work, without having to shut down other radiators.

The presetting cone which is integrated into the shut-off cone makes a hydraulic balance possible through presetting.

The presetting is consistent, i. e. it is not changed when the shut-off is activated.

Sample application

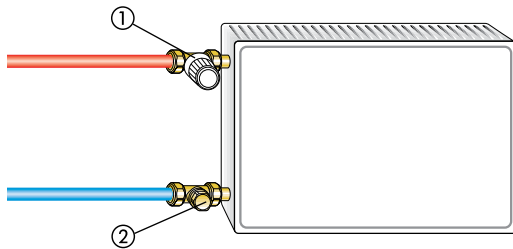

1. Thermostatic valve

2. Regulux

Press-Connection with Viega SC-Contur

Regulux radiator lockshields with 15 mm Viega press connection are suitable for copper pipes conforming to EN 1057 as well as Viega Sanpress stainless steel and Prestabo steel pipes.

All press connections as well as the valve bodies are made of corrosion-resistant, dezincification-free gunmetal.

Since this is a Viega press connection, all suitable Viega press-fitting jaws can be used. This means there is no need to purchase costly press-fitting tools and jaws.

The pressing action is produced by a formed hexagon recess before and after the beading of the connector and gives the press-fitted joint the necessary strength. In addition, the press-fitting beading is specifically formed such as to give the highgrade EPDM sealing element its defined shape.

In the interest of safety, the press connections are equipped with SC-Contur (SC = safety connection) which makes it possible to detect non-pressed joints by visible leaks when filling the system. During the press-fitting operation, the SC-Contur is practically reformed and loses its effect in the process, thus producing a permanent, tight and positive joint connection.

Initially, press-fitting joints that do not feature SC-Contur can appear to be tight in the non-pressed state, however, they can slide apart during subsequent operation of the system.

The hexagon on the valve bodies is a particularly practical feature for holding the fittings while tightening the union nut.

The following press-fitting tools can be used, e.g.

- Viega: Type 2, PT3-H, PT3-EH, PT3-AH, battery-powered Presshandy, Pressgun 4E/4B
- Geberit: PWH 75
- Geberit /Novopress: Type N 230V, Type N battery-powered
- Mapress/Novopress: EFP 2, ACO 1/ ECO 1
- Klauke: UAP 2

The suitability of other press-fitting tools should be verified with the respective manufacturer.

We recommend using only Viega press-fitting jaws to make Viega press connections.

Notes

To avoid damage and the formation of scale deposit in the hot-water heating system, the composition of the heat transfer medium should be in accordance with the VDI guideline 2035. For industrial and long-distance energy systems, see the applicable codes VdTÜV and 1466/AGFW FW 510. A heat transfer medium containing mineral oils, or any type of lubricant containing mineral oil can have extremely negative effects and usually lead to the disintegration of EPDM seals. When using nitrite-free frost and corrosion resistance solutions with an ethylene glycol base, pay close attention to the details outlined in the manufacturers' documentation, particularly concerning concentration and specific additives.

Technical data

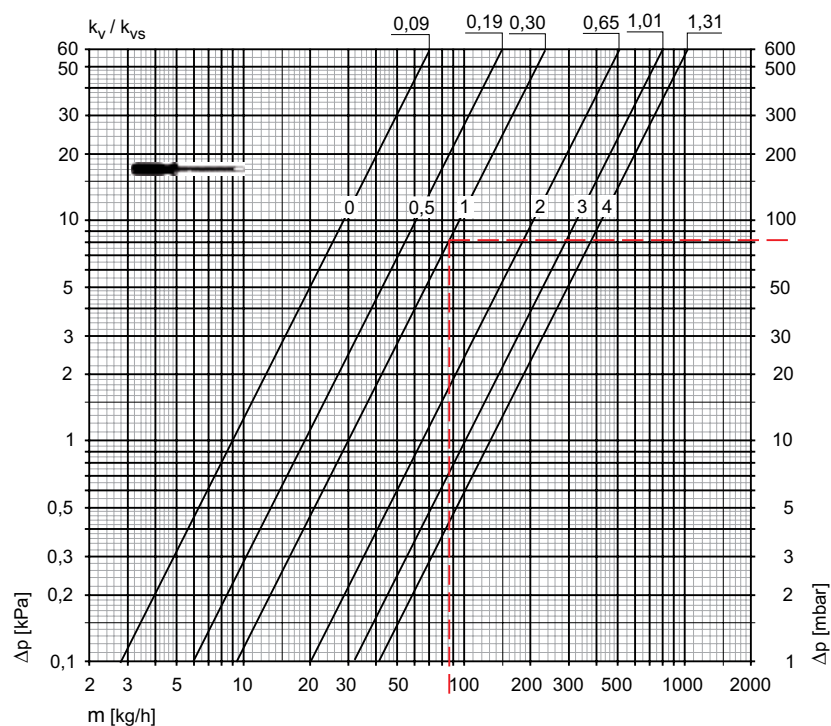

$K_v/K_{vs} = \text{m}^3/\text{h}$ at a pressure drop of 1 bar.

Sample calculation

Target:

Preset value

Given:

Differential pressure to be throttled $\Delta p = 82 \text{ mbar}$

Heat flow $Q = 2000 \text{ W}$

Temperature spread $\Delta t = 20 \text{ K (70/50}^\circ\text{C)}$

Solution:

Mass flow $m = Q / (c \cdot \Delta t) = 2000 / (1,163 \cdot 20) = 86 \text{ kg/h}$

No. of screwdriver turns = 1.0 (from the diagram)

$$C_v = \frac{K_v}{0,86}$$

$$K_v = C_v \cdot 0,86$$

Operation

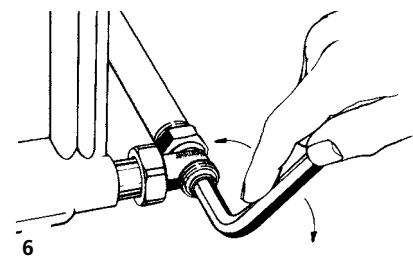
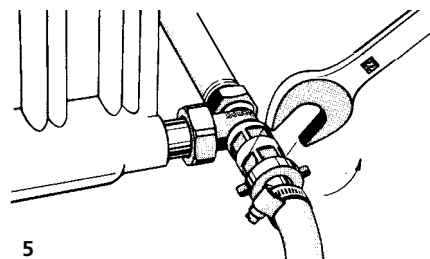
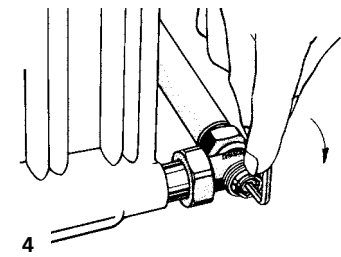
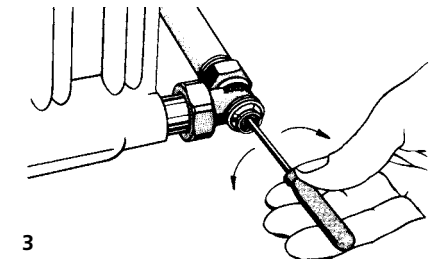
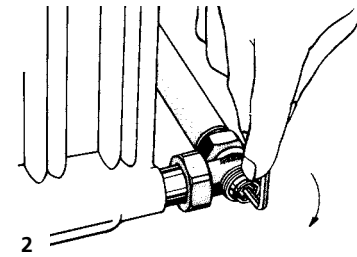
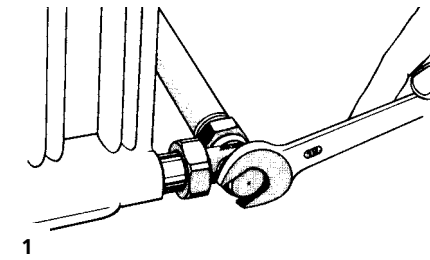

Presetting

Unscrew the closing cap with an open-jawed spanner SW 19 (fig. 1). Close the spindle by turning it to the right until it stops with a 5 mm hexagonal key (fig. 2).

Using a 4 mm screw driver, screw in the presetting cone until it stops (smallest setting value 0).

Set the required mass flow by turning the screw to the left (fig. 3). The setting value should be taken from the diagram.

With a 5 mm hexagonal key, open the spindle by turning it to the left until it stops. Unscrew the closing cap and tighten with an open-jawed spanner SW 19 (fig. 1).

The presetting is not changed when the radiator is drained off.

Shutting off, draining off and filling

Unscrew the closing cap using an open-jawed spanner SW 19 (fig. 1).

Close the shut-off spindle by turning it to the right until it stops with a 5 mm hexagonal key (fig. 2).

Using a 10 mm hexagonal key, gently loosen the thrust piece by turning it to the left (fig. 6).

Screw the drain-off and filling device Art. no. 0301-00.102 onto the thread of the Regulux lockshield and gently tighten the lower hexagonal nut with an open-jawed spanner SW 22.

Screw the hose connecting piece (1/2" hose) onto the connector thread of the drain-off and filling device. Using an open-jawed spanner SW 22, loosen the upper hexagonal nut on the side of the hose connecting piece and open up until it stops by turning it to the left. **Attention: The supply valve must be closed.**

For thermostatic valves, replace the thermostatic head with a protection cap and close the valve. Vent the radiator! The end of the hose must be lower than the radiator (fig. 5). The radiator can be dismantled. For thermostatic valves, secure the valve body with a locking cap.

Draining off the radiator without a drain-off device

Unscrew the closing cap with an open-jawed spanner SW 19 (fig. 1). Close the shut off spindle by turning it to the right until it stops with a 5 mm hexagonal key.

Attention: The supply valve must be closed.

Loosen the thrust piece by turning it to the left with a 10 mm hexagonal key (use the flat containers for draining off). Vent the radiator! The radiator can be dismantled. Tighten the thrust piece by turning it to the right with a 10 mm hexagonal key by approx. 6–8 Nm (fig. 6).

To fill the radiator, follow the above instructions in reverse order.

Articles

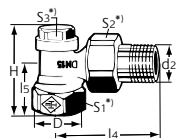

Angle

DN	D	d2	l4	l5	H	Kvs	EAN	Article No
10	Rp3/8	R3/8	52	22	50	1,31	4024052117512	0351-01.000
15	Rp1/2	R1/2	58	26	54	1,31	4024052117611	0351-02.000
20	Rp3/4	R3/4	65,5	28,5	56,5	1,31	4024052117819	0351-03.000

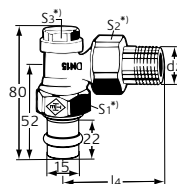

Angle

with Viega press connection 15 mm

DN	d2	l4	Kvs	EAN	Article No
15	R1/2	58	1,31	4024052545117	0341-15.000

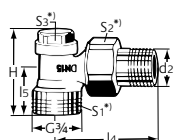

Angle

with male thread G 3/4

DN	d2	l4	l5	H	Kvs	EAN	Article No
15	R1/2	58	26	54	1,31	4024052119318	0361-02.000

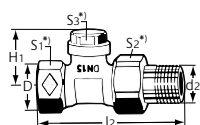

Straight

DN	D	d2	l2	H1	Kvs	EAN	Article No
10	Rp3/8	R3/8	75	33,5	1,31	4024052118113	0352-01.000
15	Rp1/2	R1/2	80	33,5	1,31	4024052118212	0352-02.000
20	Rp3/4	R3/4	90,5	33,5	1,31	4024052118311	0352-03.000

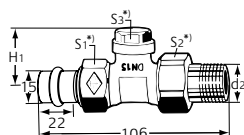

Straight

with Viega press connection 15 mm

DN	d2	H1	Kvs	EAN	Article No
15	R1/2	33,5	1,31	4024052545216	0342-15.000

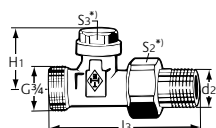

Straight

with male thread G 3/4

DN	d2	l3	H1	Kvs	EAN	Article No
15	R1/2	88	33,5	1,31	4024052120116	0414-02.000

*) S1: DN10=22mm, DN15=27mm, DN20=32mm
 S2: DN10=27mm, DN15=30mm, DN20=37mm
 S3: DN10-20=19mm

Length according to DIN 3842 part 1.

Kvs = m³/h at a pressure drop of 1 bar and fully open valve.

Accessories

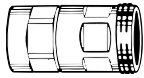

Draining off and filling device

for 1/2"-hose connection.

EAN

Article No

4024052114511

0301-00.102

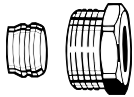

Compression fitting

for copper or precision steel pipe according to DIN EN 1057/10305-1/2. Female thread connection Rp3/8 – Rp3/4. Metal-to-metal joint. Brass nickel-plated. Support sleeves should be used for a pipe wall thickness of 0.8 – 1 mm. Follow the specifications of the pipe manufacturer.

Ø Pipe

DN

EAN

Article No

12	10 (3/8")	4024052174614	2201-12.351
----	-----------	---------------	-------------

15	15 (1/2")	4024052175017	2201-15.351
----	-----------	---------------	-------------

16	15 (1/2")	4024052175116	2201-16.351
----	-----------	---------------	-------------

18	20 (3/4")	4024052175215	2201-18.351
----	-----------	---------------	-------------

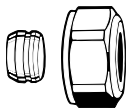

Compression fitting

for copper or precision steel pipe according to DIN EN 1057/10305-1/2. Connection male thread G3/4 according to DIN EN 16313 (Eurocone). Metal-to-metal joint. Brass nickel-plated. With a pipe wall thickness of 0.8-1 mm insert supporting sleeves. Heed pipe manufacturer's technical advice.

Ø Pipe

EAN

Article No

12		4024052214211	3831-12.351
----	--	---------------	-------------

15		4024052214617	3831-15.351
----	--	---------------	-------------

16		4024052214914	3831-16.351
----	--	---------------	-------------

18		4024052215218	3831-18.351
----	--	---------------	-------------



Support sleeve

for copper or precision steel pipe with a 1 mm wall thickness. Brass.

L

Ø

EAN

Article No

25,0	12	4024052127016	1300-12.170
------	----	---------------	-------------

26,0	15	4024052127917	1300-15.170
------	----	---------------	-------------

26,3	16	4024052128419	1300-16.170
------	----	---------------	-------------

26,8	18	4024052128815	1300-18.170
------	----	---------------	-------------

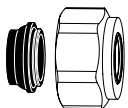

Compression fitting

for copper or precision steel pipe according to DIN EN 1057/10305-1/2 and stainless steel pipe. Connection male thread G3/4 according to DIN EN 16313 (Eurocone). Soft sealed, max. 95°C. Nickel-plated brass.

Ø Pipe

EAN

Article No

15		4024052515851	1313-15.351
----	--	---------------	-------------

18		4024052516056	1313-18.351
----	--	---------------	-------------

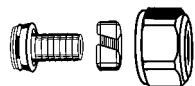

Compression fitting

for plastic pipe according to DIN 4726, ISO 10508. PE-X: DIN 16892/16893, EN ISO 15875; PB: DIN 16968/16969. Connection male thread G 3/4 according to DIN EN 16313 (Eurocone). Nickel plated brass.

Ø Pipe

EAN

Article No

14x2		4024052134618	1311-14.351
------	--	---------------	-------------

16x2		4024052134816	1311-16.351
------	--	---------------	-------------

17x2		4024052134915	1311-17.351
------	--	---------------	-------------

18x2		4024052135110	1311-18.351
------	--	---------------	-------------

20x2		4024052135318	1311-20.351
------	--	---------------	-------------



Compression fitting

for Alu/PEX multi-layer pipe according to DIN 16836. Nickel-plated brass.

Ø Pipe

EAN

Article No

Male thread connection G 3/4 according to DIN EN 16313 (Eurocone)

16x2		4024052137312	1331-16.351
------	--	---------------	-------------

Female thread connection Rp 1/2

16x2 *)		4024052138616	1335-16.351
---------	--	---------------	-------------

*) can be used for valve from 04.1995

