

PM 512



Differential pressure relief valves

Pressure relief valve

PM 512

A pressure relief valve for use in variable flow heating and cooling systems, the PM 512 features a soft NBR diaphragm that delivers a long lifetime and is also equipped with an auxiliary spring that operates as a fail-safe open function. Designed for easy handling in tight spaces. Electrophoretically painted ductile iron body for optimum rust protection.

Key features

> Inline design

Inline flow allows high pressure drops without noise.

> Pneumatic spring

Allows adjustable set-point from 0 to 16 bar.



Technical description

Application:

Heating and cooling systems with variable flow.

Function:

Inline pressure relief valve with pneumatic spring. Opens at increasing inlet pressure.

Dimensions:

DN 15-125

Pressure class:

PN 25 or PN 16 (DN 100-125)

Max. differential pressure (Δp_V):

1 600 kPa = 16 bar

Setting range:

0-16 bar

Temperature:

Max. working temperature: 100°C
Min. working temperature: -10°C

Media:

Water or neutral fluids, water-glycol mixtures (0-57%).

Material:

Valve body: Ductile iron EN-GJS-400-15
Diaphragms and gaskets: NBR, EPDM

Surface treatment:

Electrophoretic painting.

Marking:

IMI TA, DN, PN, Kvs, material and flow direction arrow.

Flanges:

DN 15-50 (optional): According to EN-1092-2:1997, type 16.
DN 65-125: According to EN-1092-2:1997, type 21.

Operating function

The pressure from the inlet acts through an internal impulse pipe (Δp^-) on the outlet side of the diaphragm (1) and together with the spring force (3) opens the valve.

Compressed gas pressure from the pressure vessel (4) acts through another impulse pipe (Δp^+) on the inlet side of the diaphragm and closes the valve.

As long as the forces that act on the diaphragm are in equilibrium, the valve seat stands still. If the inlet pressure rises, the valve opens until it reaches equilibrium.

In the unlikely event of a diaphragm rupture the pressures on both sides of the diaphragm are the same and the fail-safe spring fully opens the valve.

The force of the spring corresponds to 20 kPa differential pressure on the diaphragm.

(DN 65-125)

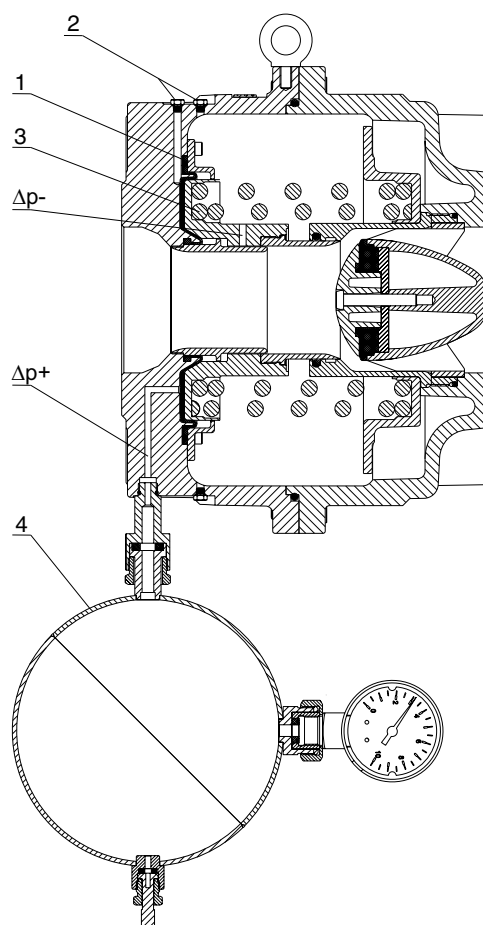

Sizing

Select the size according to the maximum speed. To prevent noise, the maximum speed should not exceed 2 m/s in residential buildings and 3 m/s in industrial buildings.

Control the pressure drop in the valve using the equation:

$$\Delta p = \left(\frac{q}{100 \times Kvs} \right)^2 \quad [\text{kPa, l/h}]$$

Installation

The flow direction is shown by arrow on the valve's identification plate (5). The recommended position is horizontal with vent screws (2) on top.

Installation of a strainer upstream of the pressure relief valve is not recommended, as it can reduce or prevent the flow. It is important to ensure that the working temperature and pressure do not exceed the recommended values.

Before you mount the controller, check the fitting length of the controller and distance between connections on the pipeline. Fit the connections (welding and threaded ends) to the pipeline first, then clean the welding remains if needed. The controller can then be installed. If flanged connections are used, check the pitch diameter and the diameter of the screw holes.

Once the pipeline and the controller are filled with water and the pressure is stabilised, vent the controller using the vent screws.

Normal pipe fittings

Try to avoid mounting taps and pumps immediately before the valve.

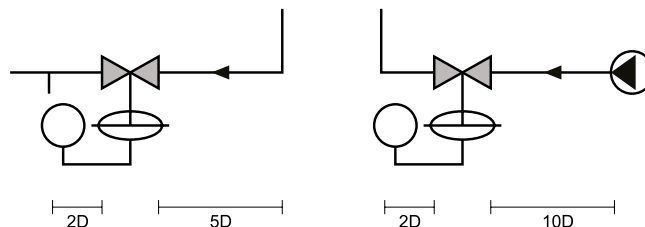

Application example

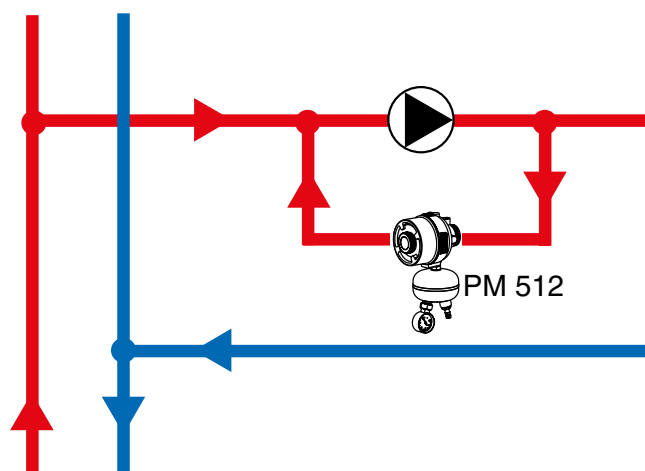

Setting

Fill the pressure vessel with compressed air or nitrogen. The pressure in the pressure vessel should be 20 kPa higher than the desired pressure in the system.

On PM 512 the pressure can be controlled using a pressure gauge on the pipeline or through a pressure gauge on the pressure vessel.

Articles

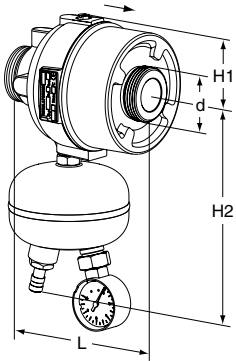

DN 15-50

DN	d	L	H1	H2	Kvs	Kg	EAN	Article No
PN 25								
15/20	G1	106	45	143	4	1,0	3831112505131	52 766-120
25/32	G1 1/4	125	55	161	12	1,7	3831112505148	52 766-125
40/50	G2	131	75	198	30	4,4	3831112505155	52 766-140

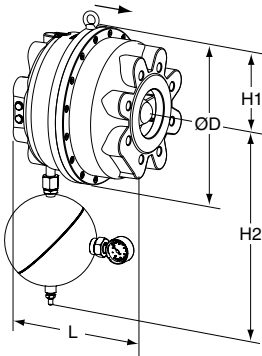

DN 65-125

DN	D	L	H1	H2	Kvs	Kg	EAN	Article No
PN 25 (DN 65 and 80 also fit PN 16 flanges)								
65	200	160	100	390	60	14	3831112500242	52 766-165
80	200	160	100	390	60	14	3831112504110	52 766-180
100	320	254	160	430	150	60	3831112525818	52 766-190
125	320	254	160	430	150	60	3831112504523	52 766-191
PN 16								
100	320	254	160	430	150	60	3831112505704	52 766-390
125	320	254	160	430	150	60	3831112505711	52 766-391

Kvs = m³/h at a pressure drop of 1 bar and fully open valve.
 → = Flow direction

Connections for DN 15-50

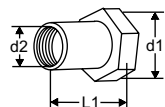
**With female thread**

Threads according to ISO 228.
Swivelling nut

d1	d2	L1*	EAN	Article No
G1	G1/2	26	3831112501027	52 759-015
G1	G3/4	32	3831112501034	52 759-020
G1 1/4	G1	47	3831112501041	52 759-025
G1 1/4	G1 1/4	52	3831112501058	52 759-032
G2	G1 1/2	52	3831112503489	52 759-040
G2	G2	64,5	3831112503205	52 759-050

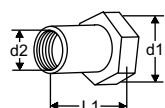
**With female thread Rc**

Threads according to ISO 7-1
Swivelling nut

d1	d2	L1*	EAN	Article No
G1	Rc1/2	26	3831112527454	52 751-301
G1	Rc3/4	32	3831112527461	52 751-302
G1 1/4	Rc1	47	3831112527478	52 751-303
G1 1/4	Rc1 1/4	52	3831112527485	52 751-304
G2	Rc1 1/2	52	3831112527492	52 751-305
G2	Rc2	64,5	3831112527508	52 751-306

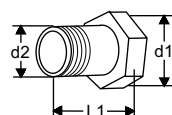
**With male thread**

Threads according to ISO 7
Swivelling nut

d1	d2	L1*	EAN	Article No
G1	R1/2	34	3831112500983	52 759-115
G1	R3/4	40	3831112500990	52 759-120
G1 1/4	R1	40	3831112501003	52 759-125
G1 1/4	R1 1/4	45	3831112501010	52 759-132
G2	R1 1/2	45	3831112503342	52 759-140
G2	R2	50	3831112503472	52 759-150

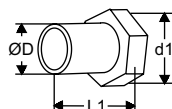
**For welding**

Swivelling nut

d1	D	L1*	EAN	Article No
G1	20,8	37	3831112500945	52 759-315
G1	26,3	42	3831112500952	52 759-320
G1 1/4	33,2	47	3831112500969	52 759-325
G1 1/4	40,9	47	3831112500976	52 759-332
G2	48,0	47	3831112501140	52 759-340
G2	60,0	52	3831112501294	52 759-350

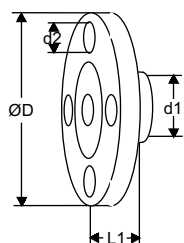
**With flange**

Flange according to EN-1092-2:1997,
type 16.

d1	d2	D	L1*	EAN	Article No
G1	M12	95	10	3831112501065	52 759-515
G1	M12	105	20	3831112501072	52 759-520
G1 1/4	M12	115	5	3831112504318	52 759-525
G1 1/4	M16	140	15	3831112501096	52 759-532
G2	M16	150	5	3831112504325	52 759-540
G2	M16	165	20	3831112501317	52 759-550

*) Fitting length (from the gasket surface to the end of the connection).