

Globo D



Ball valves

Drinking water ball valve made of gunmetal

Globo D

The Globo D is used in drinking water applications as a multifunctional shut-off valve. Thanks to the compact working radius of the operating toggle, the Globo D is ideal valve for adjacent installation on distributors.

Key features

- > **Body and ball made of corrosion-resistant gunmetal**
- > **Also available in Press version**
- > **Tubular body, ideal for continuous pipe insulation**
- > **DN 15-32 suitable for M106 actuator**
- > **Operating toggle outside the pipe insulation**



Technical description

Application:

Tap water systems

Functions:

Shut-off:

Operating toggle which can be dismantled, made of shock resistant plastic with small projection. Since the toggle stop is hidden, there is no danger of injury.

Thermometer for checking the medium temperature, retrofittable by simply replacing the green closing cap in the operating toggle, see accessories.

Draining (0675 and 0676)

Dimensions:

Versions without drain-off with female thread from DN 15 to DN 50 or Viega press connection with SC-Contur from DN 15 to DN 32.

Versions with drain-off with female/male thread or Viega press connection/male thread from DN 15 to DN 32.

Pressure class:

PN 16

Temperature:

Permissible operating temperature TB -10 °C – 120 °C, with press connection TB 110 °C, with drain-off TB 95 °C.

Material:

The body and the ball are made of corrosion-resistant gunmetal. Ball with smooth straight bore. Maintenance-free spindle sealing by two O-rings made of EPDM. Ball sealing from pure PTFE.

Insulation:

Heat insulation shells for versions with female thread and press connection, consisting of two interlocked half shells, see accessories.

Actuators:

DN 15 - 32 suitable for M106 actuators. Article No. 230 V: 0600-00.700 24 V: 0600-01.700

Approvals:

Globo D meets the following requirements: DVGW W 570-1, DVGW W 270, DIN EN 13828, DIN 50930-6 and KTW. Classified in accordance with DIN 4109 in Valve Group I (tested in accordance with EN ISO 3822 Part 1 and Part 3).

Construction

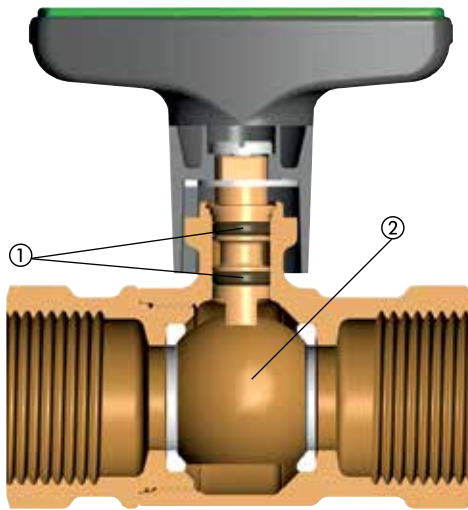

1. Stem sealing provided by two O-rings
2. Solid gunmetal ball

Application

The Globo D is used in drinking water applications as a multifunctional shut-off valve.

Thanks to the compact working radius of the operating toggle, the Globo D is ideal valve for adjacent installation on distributors. The drinking water ball valve allows insulation against heat loss as required by the respective energy saving ordinance.

On versions with female thread, this requirement can be easily met by the use of heat insulation shells or with straight pipe insulation in view of the tube-shaped housing. The operating toggle is located outside the heat insulation.

The version with drain-off and male thread makes it possible to make a detachable joint using suitable HEIMEIER screw connections with a threaded, soldered or press nipple. The male thread is also suitable for the use of other flat-sealing screw connections with direct clamping or slide joint.

Globo D meets the following requirements:

- DVGW W 570-1 (Drinking water installation, e.g. manually operated ball valves, – requirements and tests).
- DVGW W 270 (Testing and evaluation of the propagation of microorganisms on materials in drinking water applications).
- DIN EN 13828 (Manually operated ball valves for drinking water installations in buildings).
- DIN 50930-6 (Corrosion of metallic materials under corrosion load by water inside tubes, tanks and apparatus – influence of the composition of drinking water)
- KTW (Recommendation for plastics and other non-metallic materials)
- Excellent noise characteristics, classified in accordance with DIN 4109 in Valve Group I (tested in accordance with EN ISO 3822 Part 1 and Part 3).

Press connection

Globo ball valves with Viega press connection are suitable for copper pipes conforming to EN 1057 as well as Viega Sanpress stainless steel and Prestabo steel pipes.

All press connections as well as the valve bodies are made of corrosion-resistant, dezincification-free gunmetal.

Suitability press-fitting tools should be verified with the respective manufacturer.

We recommend using only Viega press-fitting jaws to make Viega press connections.

Sample application

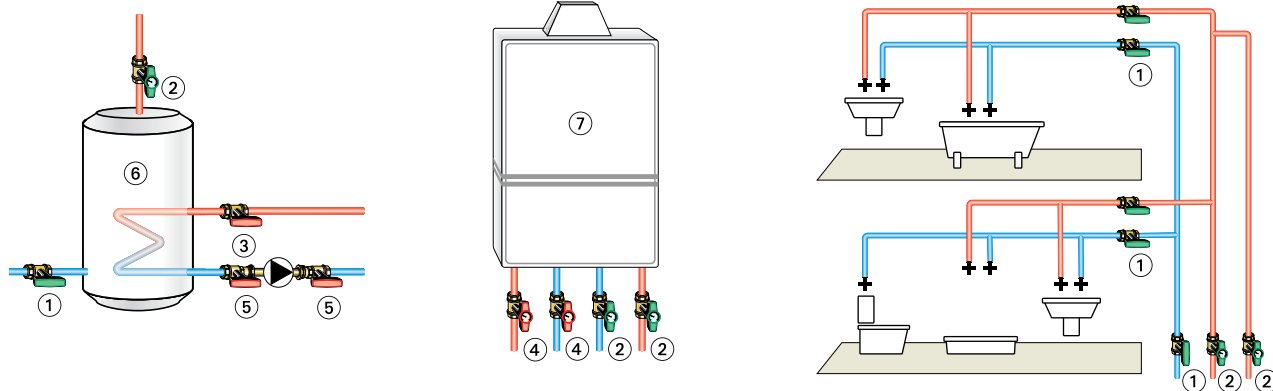

- 1. Globo D
- 2. Globo D with thermometer
- 3. Globo H
- 4. Globo H with thermometer
- 5. Globo P
- 6. Drinking water heater
- 7. Circulating water heater

Diagram

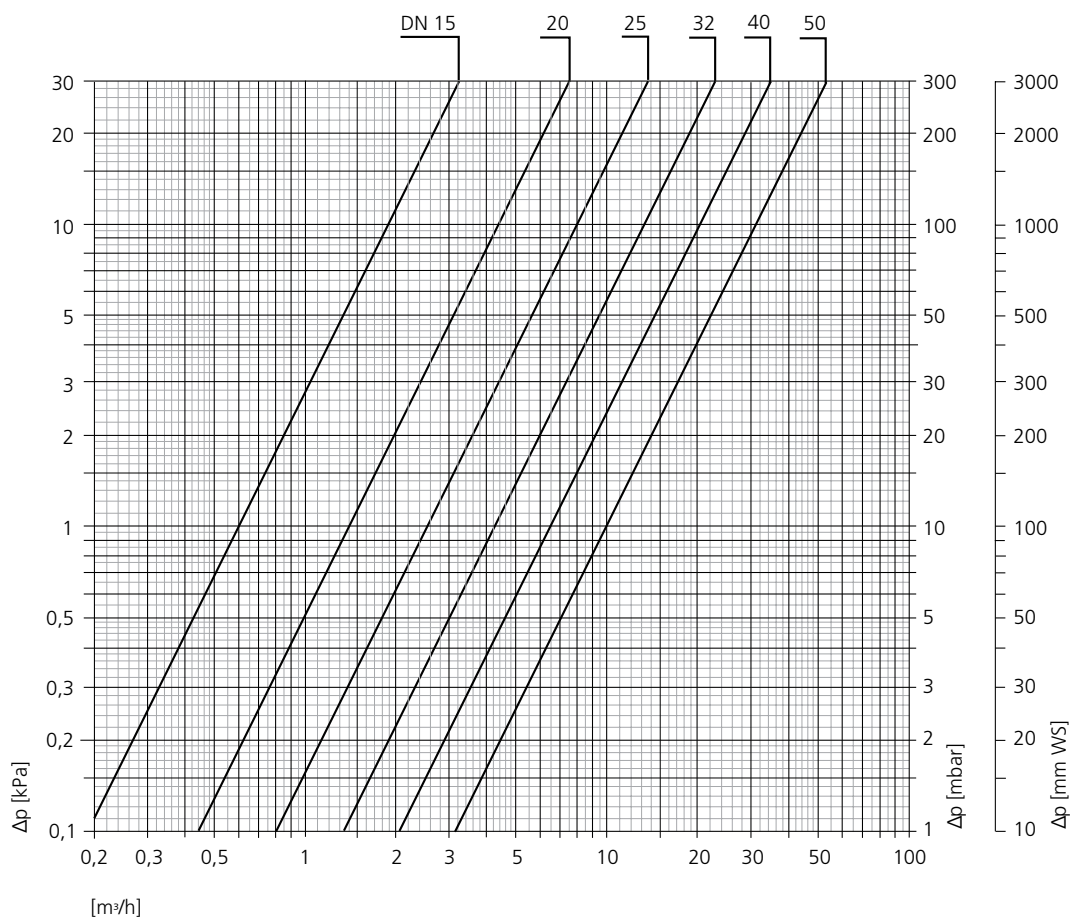

Articles

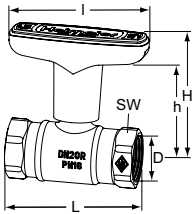

With female thread

DN	D	L	I	H	h	Kvs	EAN	Article No
15	Rp1/2	65	81	69,9	54,0	6,0	4024052557615	0670-02.000
20	Rp3/4	75	81	72,0	55,5	14,0	4024052557714	0670-03.000
25	Rp1	90	81	74,5	58,0	25,0	4024052557813	0670-04.000
32	Rp1 1/4	95	81	78,0	61,5	42,0	4024052557912	0670-05.000
40	Rp1 1/2	100	120	111,5	92,0	65,0	4024052599417	0670-06.000
50	Rp2	118	120	116,5	97,0	100,0	4024052599516	0670-08.000

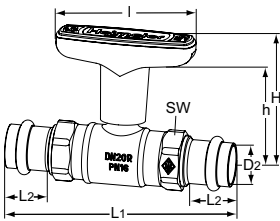

With Viega press connection with SC-Contur

DN	D2	L1	L2	I	H	h	Kvs	EAN	Article No
15	15	120	22	81	69,0	54,0	6,0	4024052558018	0672-15.000
20	22	132	23	81	72,0	55,5	14,0	4024052558117	0672-22.000
25	28	151	23	81	74,5	58,0	25,0	4024052558216	0672-28.000
32	35	157	25	81	78,0	61,5	42,0	4024052558315	0672-35.000

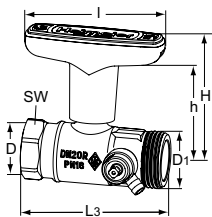

Female/male thread

With drain-off

DN	D	D1	L3	I	H	h	Kvs	EAN	Article No
15	Rp1/2	G3/4	75	81	69,0	54,0	6,0	4024052595914	0675-02.000
20	Rp3/4	G1	82	81	72,0	55,5	14,0	4024052596010	0675-03.000
25	Rp1	G1 1/4	95	81	74,5	58,0	25,0	4024052596119	0675-04.000
32	Rp1 1/4	G1 1/2	106	81	78,0	61,5	42,0	4024052596218	0675-05.000

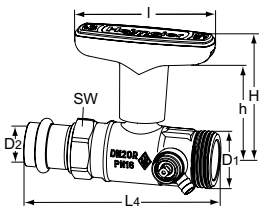

With Viega press connection with SC-Contur/male thread

With drain-off

DN	D1	D2	L4	I	H	h	Kvs	EAN	Article No
15	G3/4	15	102	81	69,0	54,0	6,0	4024052596317	0676-15.000
20	G1	22	110	81	72,0	55,5	14,0	4024052596416	0676-22.000
25	G1 1/4	28	126	81	74,5	58,0	25,0	4024052596515	0676-28.000
32	G1 1/2	35	137	81	78,0	61,5	42,0	4024052596614	0676-35.000

SW: DN 15 = 27 mm, DN 20 = 32 mm, DN 25 = 39 mm, DN 32 = 50 mm, DN 40 = 55 mm, DN 50 = 70 mm

Installation length L according to DIN 3202 part 4, row M5.

Accessories

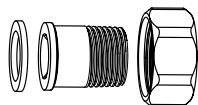

Screw connections with threaded nipple

Flat-sealing, for Globo with male thread.
Made of gunmetal.

L [mm]	DN Globo		EAN	Article No
26,5	15	R1/2	4024052599615	0675-02.350
35,5	20	R3/4	4024052599714	0675-03.350
37,5	25	R1	4024052599813	0675-04.350

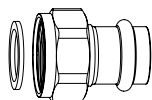

Screw connections with press nipple

Viega press connection with SC-Contur
Flat-sealing, for Globo with male thread.
Made of gunmetal.

L [mm]	DN Globo	Ø	EAN	Article No
34	15	15	4024052600519	0675-15.356
39	20	22	4024052600618	0675-22.356
44	32	35	4024052600816	0675-35.356

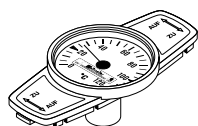

Thermometer

to replace by changing the green closing cap.
Temperatur range from 0 °C to 120 °C.

DN Globo	EAN	Article No
Red		
10-32	4024052423316	0600-00.380
40-50	4024052554812	0600-06.380
Blue		
10-32	4024052460618	0600-01.380
40-50	4024052554911	0600-07.380



Replacement handle

For	DN	EAN	Article No
Globo H, P, P-S, D	10-32	4024052123612	0600-03.520
Globo H, D	40-50	4024052124015	0600-06.520



Heat insulating shell

Made of EPP
Fire class B2

DN Globo	EAN	Article No
Without drain-off		
15	4024052575015	0670-02.553
20	4024052575114	0670-03.553
25	4024052575213	0670-04.553
32	4024052575312	0670-05.553
40	4024052599219	0670-06.553
50	4024052599318	0670-08.553

The products, texts, photographs, graphics and diagrams in this document may be subject to alteration by IMI Hydronic Engineering without prior notice or reasons being given. For the most up to date information about our products and specifications, please visit www.imi-hydronic.com.