

DA 516 – NPT threads/ANSI flanges



Differential pressure controllers

With adjustable set-point – DN 15-50

DA 516

– NPT threads/ANSI flanges

This compact differential pressure controller for heating and cooling systems is particularly effective in situations requiring high temperatures and/or pressure drop. DA 516 can be used both on the primary and secondary side in district heating and comfort cooling systems. Rust protection is assured thanks to the electrophoretic painted ductile iron body.



Key features

- > **Inline design**
Inline flow allows high pressure drops without noise.
- > **Adjustable set-point**
Delivers desired differential pressure ensuring accurate balancing.
- > **Measuring point**
Simplifies the balancing procedure, increases its accuracy and enables troubleshooting.

Technical description

Application:

Heating and cooling systems.
Installation in the return pipe.

Functions:

Differential pressure control
Pre-setting Δp over the load (Δp_L)
Measuring (Δp_L)

Dimensions:

DN 15-50

Pressure class:

PN 25

Max. differential pressure (Δp_V):

1600 kPa = 16 bar

Setting range:

Δp over the load is adjustable within:
5-30 kPa, 10-60 kPa, 10-100 kPa or
60-150 kPa.

Delivery setting:

Maximum value (30, 60, 100 resp.
150 kPa).

Temperature:

Max. working temperature:
- with measuring points: 120°C
- without measuring points: 150°C
Min. working temperature: -10°C

Media:

Water or neutral fluids, water-glycol
mixtures (0-57%).

Material:

Valve body: Ductile iron EN-GJS-400-15
Diaphragms and gaskets: EPDM
Adjustment ring: Ryton PPS

Surface treatment:

Electrophoretic painting.

Marking:

IMI TA, Size, PN, Material, Kvs/Cvs, Δp
and flow direction arrow.

Connection:

Male thread according to ISO 228.
Separate connections (NPT threaded/
ANSI flanged) available.

Operating function

The pressure upstream of the load acts through an external capillary pipe ($\Delta p+$) on the plus side of the diaphragm (1) and attempts to close the valve.

The pressure downstream of the load acts via an internal capillary pipe in the valve body and attempts, together with the spring (3) force, to open the valve. In this way, the differential pressure over the load is kept constant on the set value.

The spring force can be adjusted by turning the adjustment ring (5). Adjustment can be fixed by tightening the fixing screw (4).

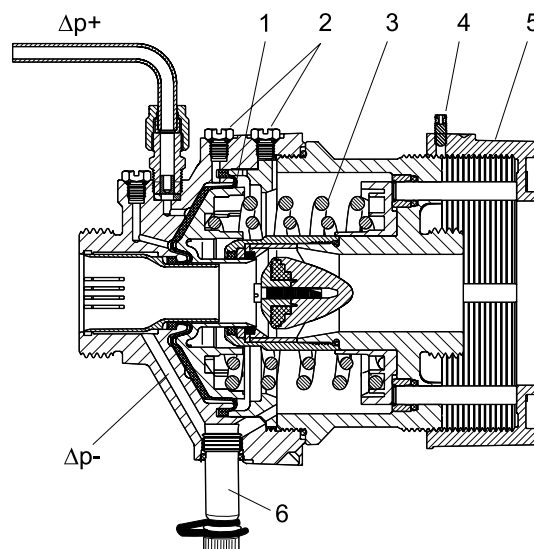

Sizing

1. Select the smallest size for the designed flow according to the diagram.
2. Check that the available Δp is bigger than the pressure drop of the valve at the designed flow. The pressure drop can be found in the diagram or calculated by the formula:

$$\Delta p = \left(\frac{q}{100 \times Kvs} \right)^2 \quad [\text{kPa}, \text{l/h}]$$

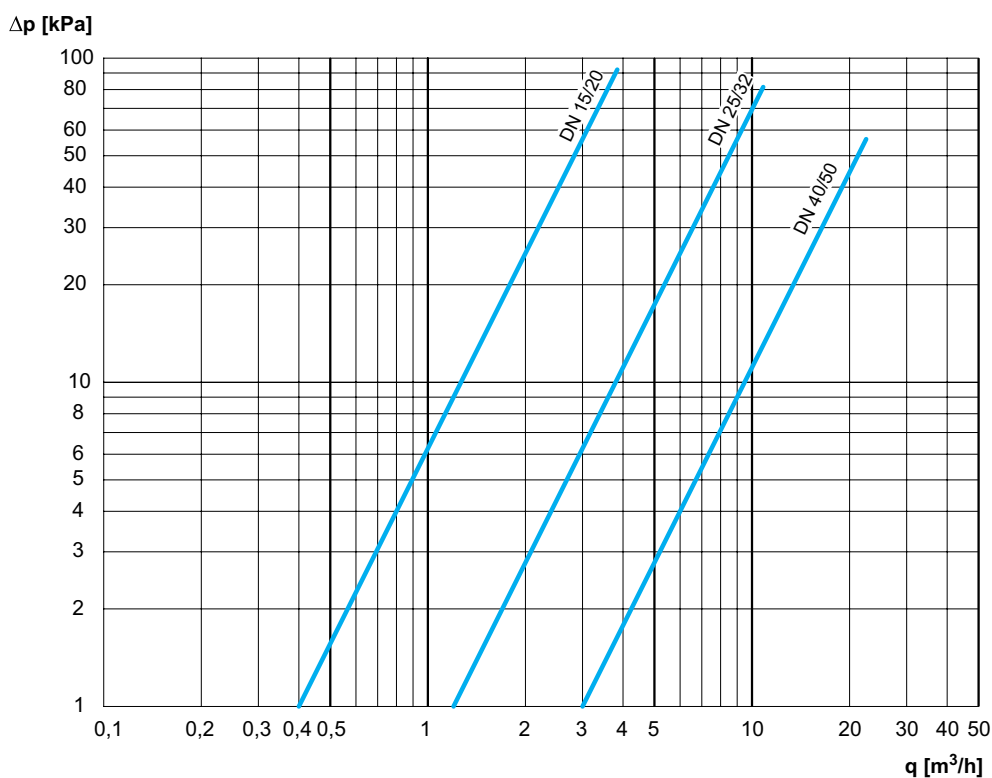

Installation

IMPORTANT: The valve body must not be disassembled.

By incorrect handling, the controller may not work properly and safety problems may occur.

The DA 516 must be installed in the return pipe. Flow direction is shown by the arrow (11) on the valve's identification plate (10). The best position is horizontal with the venting screws (2) pointing upwards.

Installation of a strainer upstream of the valve is recommended. Connect capillary pipe ($\Delta p+$, copper $\text{Ø}6 \times 1$), to the pipeline upstream of the load. In case of a horizontal pipeline connect the capillary pipe laterally to prevent air and dirt from entering. When filling, vent the connections, by using the venting screws (2). When welding the connections, the valve must be protected from too high a temperature.

Turn the adjustment ring (5) clock-wise until stop to make the nut (7) on the outlet side accessible.

If measuring point is mounted on the DA 516, the differential pressure over the load can be measured by using our balancing instrument.

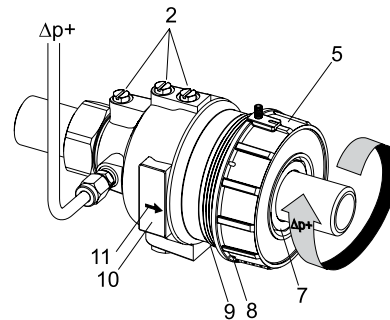

Capillary pipe

Before putting into operation, the capillary pipe must be installed. The other end of the capillary pipe is connected to the balancing valve STAD/STAF or other suitable point on the pipeline.

Setting

The differential pressure can be adjusted by turning the adjustment ring (5). The preset value can be sealed through the holes (see (8) and (9) under Installation).

DN	Number of turns	Δp [kPa] change per turn of setting nut/spanner			
		5-30	10-60	10-100	60-150
15/20	10	2,6	5,1	9,3	9,3
25/32	14	1,8	3,6	6,6	6,6
40/50	15	1,7	3,3	6,0	6,0

Measure flow and adjust Δp accordingly.

Application example

Keeping the differential pressure over a control valve constant

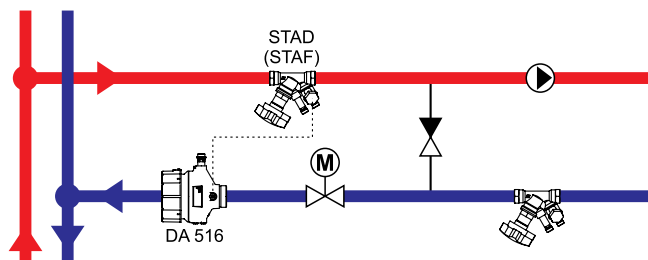

Shunt group

DA 516 should be mounted downstream of the control valve and STAD (STAF) may preferably be mounted in the supply pipe.

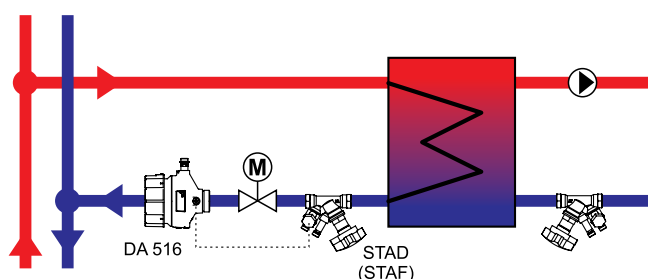

Heat exchanger

DA 516 should be mounted downstream of the control valve and STAD (STAF) upstream of the control valve, but downstream of the heat exchanger.

STAD (STAF) can be mounted in the supply pipe, but with a decreased valve authority as a consequence.

DA 516 – With measuring points (max. 120°C)

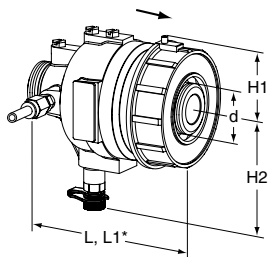

Male thread

Threads according to ISO 228. Separate connections with NPT threads or ANSI flanges – see “Connections for DN 15-50”.

Included: Capillary pipe (Ø6) 1 200 mm, connection set (G1/2+G3/4) for capillary pipe to e.g. STAD and 1 capillary pipe connection R1/4 (R1/8 mounted on valve).

PN 25

DN	d	L	L1*	H1	H2	Kvs	Kg	EAN	Article No
5-30 kPa									
15/20	G1	106	116	41	85	4	1,5	3831112507111	52 795-020
25/32	G1 1/4	125	150	51	98	12	2,6	3831112507159	52 795-025
40/50	G2	162	190	70	110	30	5,8	3831112507197	52 795-040
10-60 kPa									
15/20	G1	106	116	41	85	4	1,5	3831112507104	52 795-120
25/32	G1 1/4	125	150	51	98	12	2,6	3831112507142	52 795-125
40/50	G2	162	190	70	110	30	5,8	3831112507180	52 795-140
10-100 kPa									
15/20	G1	106	116	41	85	4	1,5	3831112507098	52 795-220
25/32	G1 1/4	125	150	51	98	12	2,6	3831112507135	52 795-225
40/50	G2	162	190	70	110	30	5,8	3831112507173	52 795-240
60-150 kPa									
15/20	G1	106	116	41	85	4	1,5	3831112507128	52 795-320
25/32	G1 1/4	125	150	51	98	12	2,6	3831112507166	52 795-325
40/50	G2	162	190	70	110	30	5,8	3831112507203	52 795-340

DA 516 – Without measuring points (max. 150°C)

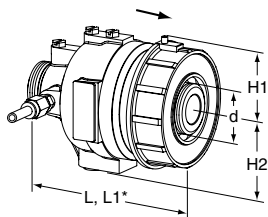

Male thread

Threads according to ISO 228. Separate connections with NPT threads or ANSI flanges – see “Connections for DN 15-50”.

Included: Capillary pipe (Ø6) 1 200 mm, connection set (G1/2+G3/4) for capillary pipe to e.g. STAD and 1 capillary pipe connection R1/4 (R1/8 mounted on valve).

PN 25

DN	d	L	L1*	H1	H2	Kvs	Kg	EAN	Article No
5-30 kPa									
15/20	G1	106	116	41	57	4	1,5	3831112528468	52 752-720
25/32	G1 1/4	125	150	51	70	12	2,6	3831112528659	52 752-725
40/50	G2	162	190	70	82	30	5,8	3831112528697	52 752-740
10-60 kPa									
15/20	G1	106	116	41	57	4	1,5	3831112528451	52 754-620
25/32	G1 1/4	125	150	51	70	12	2,6	3831112528642	52 754-625
40/50	G2	162	190	70	82	30	5,8	3831112528680	52 754-640
10-100 kPa									
15/20	G1	106	116	41	57	4	1,5	3831112528444	52 760-320
25/32	G1 1/4	125	150	51	70	12	2,6	3831112528635	52 760-325
40/50	G2	162	190	70	82	30	5,8	3831112528673	52 760-340
60-150 kPa									
15/20	G1	106	116	41	57	4	1,5	3831112528475	52 760-920
25/32	G1 1/4	125	150	51	70	12	2,6	3831112528666	52 760-925
40/50	G2	162	190	70	82	30	5,8	3831112528703	52 760-940

*) Length incl adjustment ring.

Kvs = m³/h at a pressure drop of 1 bar and fully open valve.

→ = Flow direction

Connections for DN 15-50

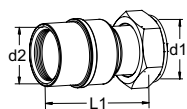

With female thread NPT

Threads according to ANSI/ASME B1.20.1-1983.
Swivelling nut

d1	d2	L1*	EAN	Article No
G1 1/4	1 NPT	73	3831112533394	52 751-307
G1 1/4	1 1/4 NPT	80	3831112533400	52 751-308
G2	1 1/2 NPT	82	3831112533417	52 751-309
G2	2 NPT	93	3831112533424	52 751-310

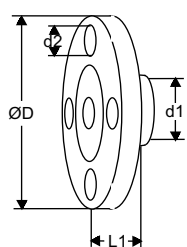

With ANSI flange

Attention! Can be used on the **inlet** side only.
According to ASME/ANSI B 16.42 Class 150.

d1	d2	D	L1*	EAN	Article No
G1	1/2"-13 UNC	89	10	3831112511811	52 759-815
G1	1/2"-13 UNC	98,5	20	3831112511835	52 759-820
G1 1/4	1/2"-13 UNC	108	5	3831112511866	52 759-825
G1 1/4	1/2"-13 UNC	117,3	15	3831112511873	52 759-832
G2	1/2"-13 UNC	127	5	3831112511897	52 759-840
G2	5/8"-11 UNC	152,4	20	3831112511491	52 759-850

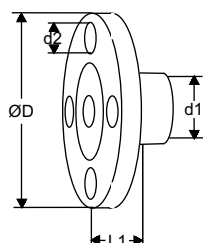

With ANSI flange (extended)

Attention! Must be used on the **outlet** side.
According to ASME/ANSI B 16.42 Class 150.

d1	d2	D	L1*	EAN	Article No
G1	1/2"-13 UNC	89	47	3831112511828	52 759-915
G1	1/2"-13 UNC	98,5	47	3831112511842	52 759-920
G1 1/4	1/2"-13 UNC	108	62	3831112511859	52 759-925
G1 1/4	1/2"-13 UNC	117,3	62	3831112511880	52 759-932
G2	1/2"-13 UNC	127	72	3831112511903	52 759-940
G2	5/8"-11 UNC	152,4	72	3831112511507	52 759-950

*) Fitting length (from the gasket surface to the end of the connection).

Other types of connections (ISO), see international version of DA 516.

Accessories

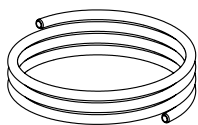

Capillary pipe

Ø6 mm
1 pc included in DA 516.

L [m]	Ø	EAN	Article No
1,2	6 mm	3831112527157	52 759-215

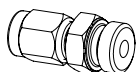

Capillary pipe connection

For capillary pipe Ø6 mm with R1/4 and R1/8 connection.
1 pc R1/4 included in DA 516 (R1/8 mounted on valve)

	DN	EAN	Article No
6 x R1/4	15-50	3831112527355	52 759-201
6 x R1/8	15-32	3831112533868	52 759-213
6 x R1/8	40-50	3831112533875	52 759-218

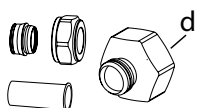

Connection set STAD

Must be used on STAD when connection of Ø6 mm capillary pipe.
2 transition nipples (G1/2 and G3/4), 1 thrust nut (Ø6), 1 cone and 1 support bush are included in DA 516.

d	EAN	Article No
G1/2	7318793850003	52 762-006
G3/4	7318793850102	52 762-106

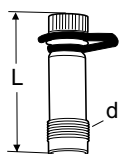

Measuring point

Max 120°C (intermittent 150°C)
AMETAL®/EPDM

d	L	EAN	Article No
M14x1	44	7318792813207	52 179-014
M14x1	103	7318793858108	52 179-015

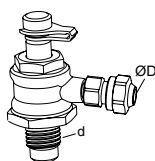

Capillary pipe connection with shut-off

For connection of Ø6 mm capillary pipe to STAF/STAF-SG.

d	D	For DN	EAN	Article No
G1/4	6	20-50	7318793999504	52 265-209
G3/8	6	65-400	7318793999405	52 265-208

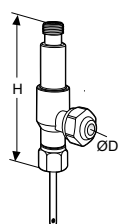

Measuring point, two-way

For connection of Ø6 mm copper pipe while permitting simultaneous use of our balancing instrument.

D	H	EAN	Article No
6	68	7318793848703	52 179-206



Measuring point, extension 60 mm

Can be installed without draining of the system.
AMETAL®/Stainless steel/EPDM

L	EAN	Article No
60	7318792812804	52 179-006

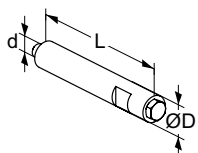

Venting extension

Suitable when insulation is used.
Stainless steel/EPDM/Brass.

d	D	L	EAN	Article No
M6	12	70	3831112531727	52 759-220



Venting screw

Brass/EPDM

d	EAN	Article No
M6	3831112527980	52 759-211

